

DOWNLOADED FROM: WWW.RETROSYNTH.COM

OPERATION MANUAL



SEQUENTIAL
Publications Department

CM2400B
April, 1986

PROPHET VS
DIGITAL VECTOR SYNTHESIZER

OPERATION MANUAL

by

Stanley Jungleib
and
Rick Davies

Sequential/Europe
Postbus 16
3640 AA Mijdrecht
Netherlands
02979-86211
Telex: 12721 SQNTL NL

Sequential
3051 North First Street
San Jose, CA 95134-2093
U.S.A.
(408) 946-5240
Telex: 4997150 SEQCIR

PROPHET VS
DIGITAL VECTOR SYNTHESIZER
OPERATION MANUAL

by **Stanley Jungleib**
and **Rick Davies**

Every attempt at accuracy has been made.
However, specifications and operations are
subject to change without notice.

©1986 by SEQUENTIAL
All rights reserved. Printed in U.S.A.

No part of this publication may be reproduced,
stored in a retrieval system, or transmitted, in
any form or by any means, electronic,
mechanical, photocopying, recording, or
otherwise, without the prior written permission of
the publisher.

TABLE OF CONTENTS

	<u>title</u>	<u>page</u>
SECTION 1	SET-UP	
	PACKING LIST	1-1
	HANDLING AND TRANSPORTING	1-1
	AMPLIFIER AND SPEAKER CONSIDERATIONS	1-2
	CONNECTIONS	1-3
	OUTPUT	1-3
	FOOTSWITCHES	1-3
	MIDI	1-4
	LINE VOLTAGE SELECTION AND FUSING	1-4
	POWER CONNECTION	1-5
	POWER ON	1-5
	DISPLAY TRIM	1-6
SECTION 2	PERFORMANCE CONTROLS	
	SELECTING PROGRAMS	2-1
	MASTER VOLUME	2-1
	BALANCE	2-1
	MASTER TUNE	2-2
	KEYBOARD	2-2
	Modes	2-3
	Position	2-3
	Velocity	2-3
	Pressure	2-3
	WHEELS	2-4
	Pitch Wheel and Pitch Wheel Range	2-4
	Mod Wheel	2-5
	WAVEFORM MIX JOYSTICK	2-5
	CHORUS LEFT/RIGHT	2-5
	ALTERNATE RELEASE FOOTSWITCH	2-5
	AUX FOOTSWITCH	2-6

SECTION 3	PROGRAMMING	
	INTRODUCTION	3-1
	MEMORY BASICS	3-1
	Internal Memory	3-1
	Cartridge Memory	3-2
	Model 240 VSRAM Cartridge	3-2
	Model 241 VSROM Cartridge	3-2
	PROGRAM EDIT MODE	3-3
	STORING PROGRAMS	3-4
	Review	3-5
	Store	3-5
	TRANSFERRING PROGRAMS AND WAVEFORMS	3-6
	Dump Internal to Cartridge	3-6
	Load Internal from Cartridge	3-7
	NAMING PROGRAMS	3-7
	PROGRAM EDIT, REVIEW, AND STORE EXAMPLE	3-8
	RANDOM PROGRAM CREATION	3-8
SECTION 4	KEYBOARD MODES	
	SINGLE MODE	4-1
	LINKING PROGRAMS	4-1
	SPLIT MODE	4-1
	DOUBLE MODE	4-3
SECTION 5	ARPEGGIATOR	
	ARPEGGIATOR BASICS	5-1
	ON-OFF/RATE	5-3
	LATCH/TRANPOSE	5-3
	Transposing	5-4
	ARPEGGIATOR OPTION SELECT	5-4
	Arpeggiator Modes	5-4
	Scan	5-5
	Octaves	5-6
	Repeats	5-6
	Split	5-6
	Voicing	5-7
	Velocity	5-7
	Layer	5-8
	Rests	5-8
	Clocks/Step	5-8

SECTION 6	OSCILLATORS	
	OVERALL SIGNAL FLOW	6-1
	Figure 6-1: General Block Diagram	6-2
	OSCILLATOR BASICS	6-3
	Figure 6-2: Oscillator Frequency Control	6-4
	OSCILLATOR MIXER	6-5
	Figure 6-3: Oscillator Mixer	6-6
	Figure 6-4: Typical Mix Ratios	6-6
	VECTOR SYNTHESIS	6-7
	OSCILLATOR GROUP CONTROLS	6-8
	Select	6-8
	Wave #	6-9
	Coarse Freq and Fine Freq	6-9
	Mixer Modulation	6-10
	THE BASIC VS PATCH	6-10
SECTION 7	FILTER	
	FILTER BASICS	7-1
	Figure 7-1: Filter Module	7-2
	CUTOFF	7-3
	RESONANCE	7-4
	ENV AMOUNT	7-5
SECTION 8	ENVELOPE GROUP	
	ENVELOPE GENERATORS	8-1
	MIXER ENVELOPE	8-2
	Figure 8-1: Mixer Envelope	8-2
	Effects of Mix Joystick	8-3
	Figure 8-2: Effects of Mix Joystick	8-3
	FILTER ENVELOPE	8-4
	Figure 8-3: Filter/Amplifier Envelope	8-4
	Figure 8-4: Envelope Examples	8-5
	Figure 8-5: Envelope Loop Examples	8-6
	AMPLIFIER	8-7
	Figure 8-6: Amplifier Module	8-7
	ENVELOPE SELECT	8-8
	BASIC MIXER ENVELOPE	8-8
	POINT	8-8
	RATE	8-9
	LEVEL	8-9
	LOOP	8-9
	REPEAT	8-10

SECTION 9	LFO GROUP	
	LFO BASICS	9-1
	Figure 9-1: LFO Module	9-1
	LFO SELECT	9-2
	SHAPE	9-2
	RATE	9-2
SECTION 10	MODULATION	
	MODULATION BASICS	10-1
	SOURCE SELECT and DESTINATION SELECT	10-1
	Figure 10-1: Modulation Sources and Destinations	10-2
SECTION 11	VOICE CONTROLS	
	UNISON/DETUNE	11-1
	GLIDE	11-1
	VOICE PAN	11-2
	Figure 11-1: Pan Module	11-2
	Panning Modulation	11-3
	PROGRAM VOLUME	11-3
SECTION 12	CHORUS	
	CHORUS BASICS	12-1
	Figure 12-1: Chorus Module	12-1
	CHORUS LEFT	12-2
	CHORUS RIGHT	12-2
	RATE/DEPTH	12-2
SECTION 13	CREATING USER WAVEFORMS	
	INTRODUCTION	13-1
	EDIT WAVEFORM MODE	13-2
	Editing Waveforms	13-2
	Wave# and Harmonic	13-3
	STORING WAVEFORMS	13-4
	Review	13-4
	Store	13-5

SECTION 14 MIDI

OVERVIEW	14-1
BASIC CONNECTIONS	14-1
Figure 14-1: Basic MIDI Connections	14-1
MIDI CHANNEL	14-3
MIDI MODE	14-3
Figure 14-2: Mode 4 Channel Ranges	14-4
MULTIPLE KEYBOARD OPERATION	14-5
Figure 14-3 Multi-Channel Operation	14-5
ARPEGGIATING WITH MIDI	14-6
Clocking the VS with MIDI Drum Machines	14-6
Clocking Other MIDI Devices	14-7
MIDI OPTIONS	14-7
Receive Mode	14-7
MIDI Wheels	14-7
MIDI Programs	14-8
MIDI Pressure	14-8
MIDI Joystick	14-9
MIDI Parameters	14-9
Arpeggiator Channel	14-10
Overflow	14-10
Program Dump	14-10
Wave Data Dump	14-11
RECEIVING WAVEFORMS FROM MIDI SAMPLERS	14-11
MIDI COMMON SAMPLE DUMP STANDARD	14-12
SPECIFICATION	14-15
Channel	14-15
System Exclusive	14-22
System Real-Time	14-25
Table 14-1: MIDI Parameters	14-26

SECTION 15 PROGRAM AND WAVEFORM DESCRIPTIONS

INTRODUCTION	15-1
PROPHET VS PROGRAM LIST	15-3
PROGRAM EXPLANATIONS	
#03 VOLKANIK	15-5
#49 AMBIENCE	15-9
#08 STEELDR	15-13
#33 CHIFF	15-17
#66 PERKEY	15-21
#40 IS THERE	15-25
#44 SATIR	15-29
#69 FILMUSIC	15-33
WAVEFORM DESCRIPTIONS	15-37

SECTION 16 PROGRAM FORMS

SECTION 1

SET-UP

This section tells you how to set up the Prophet VS and connect it to other equipment.

PACKING LIST

With the Prophet VS you should receive the following:

- Power cord
- Operation manual
- Warranty / Warranty card

Please detach and return the warranty card. (You can keep the rest of the stuff.)

HANDLING AND TRANSPORTING

The Prophet VS contains state-of-the-art digital and analog circuitry, and several physical performance controllers. As with any other high-tech instrument, the Prophet VS should be treated with as much care as you would provide an acoustic instrument. Shock or vibration can damage the keyboard, joystick, or other controls, and can loosen connectors or socketed integrated circuits. Avoid extremes of temperature and humidity.

Caution: Be especially careful of the joystick, since the way it protrudes makes it rather vulnerable.

During use, the Prophet VS should be placed on a level surface, with all feet evenly supported. No liabilities are assumed for unorthodox mounting or inadequate support.

If you expect to transport the Prophet VS even occasionally it is imperative to invest in a professional "road" or "flight" case for it. Cases are made by several manufacturers and should be carried by

your music dealer. If you prefer to build your own, there are firms that sell case hardware. If you can't find a case, please contact the Sequential Customer Service Department.

AMPLIFIER AND SPEAKER CONSIDERATIONS

This is an excellent time to think about your amplifier and speaker system. By converting the Prophet VS' electrical output into the potent vibrations you hear, the sound system becomes part of the instrument. Of course you can use anything you like or can afford. But obviously a synthesizer of this caliber should not be constrained by a weak amplifier and muddy speakers.

Consider the equipment to which you are going to connect the Prophet VS. Does it give you adequate tone control? In addition to equalization, it is generally agreed that electronically-generated music is often enhanced by ambience effects (since there is no natural resonance). If you don't already have one, strongly consider getting a good digital delay line (DDL) or reverb. You won't regret it.

For detailed, clear sound and to prevent clipping of the highly dynamic output from the Prophet VS, extraordinary amounts of amplifier headroom are needed. It is not difficult to justify committing a stereo amp of at least 200 watts per channel to a small-band performance. This may sound like a lot of power, but keep in mind that a keyboard is generally required to produce cleaner sound than a guitar, for example. As a practical matter, when the guitarist distorts, it is expected. But when the synthesist distorts it usually attracts nasty looks.

Monitoring the Prophet VS in stereo is strongly recommended. While a mono amp will suffice, a stereo configuration will be able to take advantage of the Prophet VS's separate left and right outputs, including the extensive voice positioning and panning features, and will also be able to project the shifting images created by the internal delay features and chorus, or by external delay units or spatial modifiers.

Speakers ought to be capable of handling the full amplifier power over the full audio range (20 Hz to 20 kHz) without distorting.

CAUTION! If it is not practical to use amplifiers and speakers specifically designed for electronic instruments, or if volume must be kept low, using your stereo system will generally give good high-frequency response. But if you choose this method, be careful. Continuous playing of synthesizer sounds can cause component amplifiers to overheat. Furthermore, the dynamic range of the Prophet VS places component speakers at some risk, because of powerful bass notes and transients which will damage them if the volume is set too high.

CONNECTIONS

The following paragraphs describe connections which can be made to the back panel of the Prophet VS. Except for the MIDI jacks, all signal connectors are standard 1/4-inch phone jacks.

CAUTION! Switch power off to all equipment in use before disconnecting or connecting any cable.

OUTPUT

Note: Stereo monitoring is strongly recommended.

1. To drive a monophonic amp, use the **RIGHT/MONO** jack only.
2. To drive a stereophonic preamp or amp, use both outputs.
3. To drive headphones or a stereo cable, connect them to **LEFT/PHONES**. (Be sure nothing is plugged into **RIGHT/MONO**.)

The Prophet VS has a very flexible output system. The **LEFT/PHONES** jack is a tip-ring-sleeve (TRS) type. The tip is always connected to the left channel. If **RIGHT/MONO** is disconnected, the ring of **LEFT/PHONES** is the right channel. If **RIGHT/MONO** is connected, the ring is disconnected.

The **RIGHT/MONO** jack is a tip-sleeve (TS) type. If **LEFT/PHONES** is disconnected, the **RIGHT/MONO** tip is a monophonic mix of both channels. If **LEFT/PHONES** is connected, the tip is the right channel only.

The impedance of the headphones or preamp/amp which are connected basically doesn't matter. The audio output drivers can handle virtually any load and are protected against shorts.

FOOTSWITCHES

1. Connect footswitch (not included) to the **ALTERNATE RELEASE** footswitch jack.

The footswitch should be of the type that is normally open, and is pressed to momentarily close. Sequential Model 839 is suitable.

This footswitch can be programmed to operate like a "sustain" pedal on a piano. (Actually, it switches back and forth between two release values.)

2. If a second footswitch is available, connect it to the **AUX**

footswitch jack.

The AUX footswitch duplicates the function of the Arpeggiator Latch/Transpose switch. (Again, see the main text.)

MIDI

1. Connect the **MIDI OUT** jack to the MIDI input of the slave synthesizer, or other MIDI device.
2. Connect the **MIDI IN** jack to the MIDI output of the other MIDI device. (When dumping samples, this is optional but improves the dump speed and provides error correction. For more information, see Section 8.)
3. Connect the **MIDI OUT/THRU** jack to the MIDI input of the other MIDI equipment.

If the **OUT/THRU** switch is in the **THRU** position, the data output is identical to the data appearing at the **MIDI IN** jack. If the switch is in the **OUT** position, the data output is identical to the data appearing at the **MIDI OUT** jack.

All MIDI operations, including clock input and output, are explained in Section 8.

LINE VOLTAGE SELECTION AND FUSING

CAUTION! Before connecting the power cord or switching power on, check the line voltage selector as described below. Never switch the voltage selector while power is connected.

1. Check that the voltage selector on the back panel matches your power source.

Prophet VS's shipped in the U.S., or to Canada or Japan are set to 110V. Prophet VS's shipped to Europe, Australia, or New Zealand are set to 220V.

2. If the selected voltage does not match your line voltage, switch it.

WARNING! CHANGING THE VOLTAGE SELECTOR MAY REQUIRE THE USE OF A DIFFERENT LINE CORD OR ATTACHMENT PLUG, OR BOTH. TO REDUCE THE RISK OF FIRE OR ELECTRIC SHOCK, REFER SERVICING TO QUALIFIED PERSONNEL.

3. If you switched the voltage selector, change the fuse:

<u>Voltage</u>	<u>Fuse Rating</u>
110V	1/2A (500 mA)
220V	1/4A (250 mA)

POWER CONNECTION

1. Check that the Prophet VS power switch is set to **OFF** position.
2. Connect the power cable to the Prophet VS **AC IN**.
3. Connect the power cable to a properly-grounded three-prong outlet.
4. Plug all other equipment such as effects devices, mixers, amplifiers and recorders into the same outlet.

WARNING! Do not overload. When in doubt, consult an electrician. The Prophet VS comes with a three-prong power plug to ensure safe grounding with other equipment. The ground prong is connected directly to the metal chassis. Because of this AC ground, a "ground loop" will often be created when an audio cable is connected between the Prophet VS and its amplifier. As a result, low-level hum may occur. The hum level will depend on exactly how the synthesizer and amplifier are connected to the AC. Defeating the AC ground with a two-prong adapter will usually defeat the hum but this practice can set up a shock hazard between the units. For minimal hum, use the same AC outlet for the Prophet VS and its amplifier, and all associated equipment. This should reduce the hum to an acceptable level. To prevent potentially lethal shocks, it is up to you to check the power and ground interconnections of the Prophet VS and all other instruments and equipment in use. Sequential is not responsible for any equipment failure due to incorrect AC power connections, and is not liable for any personal injury due to electrical shocks as a result of unsafe grounding practices. As you probably know, many older buildings and clubs are notorious for their poor quality AC wiring. We therefore urge you to use one of the several "ground-checking" devices available on the market to verify AC connections.

POWER ON

1. Set up as described above.
2. Switch Prophet VS **POWER** switch to **ON**.

After a moment or two, the following appears in the liquid-crystal display (LCD):

PROPHET VS
Sequential r (software level)

for three seconds, then

PROPHET VS
INT# 00 (name)

CAUTION! Before playing any key, first check that **Master Volume** is reduced to minimum. This may keep you from accidentally blowing out speakers (or your ears).

3. Switch power on to your preamp or mixer, if used, then switch amplifier power on.

Switching the equipment on in this order prevents loud pops.

DISPLAY TRIM

Due to the nature of LCDs, this display can only be read clearly from certain angles. As the VS may be mounted at different angles, it may be necessary to adjust the LCD using a trimmer accessed, through a hole in the back panel.

1. Locate the small hole in the Prophet VS back panel at the top of the "E" in the "SEQUENTIAL" logo.
2. Using a small screwdriver, adjust the potentiometer within this hole until the display gives the best contrast for the current mounting angle.

Be careful not to push too hard with the screwdriver, or the potentiometer may be pushed back too far, and made inaccessible.

3. Look at the display from several angles to make sure the adjustment is suitable.

SECTION 2

PERFORMANCE CONTROLS

SELECTING PROGRAMS

Set up the Prophet VS as described in Section 1. The Prophet VS is ready to play when power is switched on.

When power is switched on, internal sound program 00 is selected automatically, as shown in both the liquid-crystal display (LCD) and the light-emitting diode (LED) **Program** display. To select a different program, simply press two **PROGRAM SELECT** digits (00-99).

To select a cartridge program, insert a cartridge and switch **Cartridge** on; then enter the desired two digits. (If a cartridge is not in place, **Cartridge** will not go on.)

Note: The Prophet VS is basically intended to be heard in stereo.

Note: If the VS is not used for more than five minutes, the LCD back-lighting shuts itself off. It will reappear when you let the VS know you are back.

MASTER VOLUME

While playing the keyboard, gradually raise **Master Volume** to maximum while lowering the monitor system volume to a comfortable level.

For best signal-to-noise performance, set **Master Volume** as high as possible without overloading the inputs of the monitor system. **Master Volume** is best used for a temporary reduction of level.

BALANCE

The Prophet VS has two audio output channels: left and right. As **Balance** is turned to either end of its travel, the volume of one output channel increases as the other decreases. The Prophet VS can pan its voices to specific or moving positions within the stereo field.

Check that **Balance** is centered, or set as desired.

Balance is best used to temporarily compensate for stereo position of the output. Within each program there are several controls or modulators that affect the voice loudness (including **Program Volume**, velocity, or pressure), and these should be used for actually mixing levels in the Prophet VS. (For example, it is better to balance Split or Double mode programs using **Program Volume**.)

MASTER TUNE

This is perhaps the most basic performance parameter. To match the Prophet VS's tuning to other ensemble instruments such as an acoustic piano, **Master Tune** simultaneously adjusts the playback pitch of all voices over a limited range. Master tuning can also compensate for tape speed variations.

Note: **Master Tune** is a non-programmable control and affects all programs in the VS. The **Master Tune** adjustment is held in non-volatile memory while power is off. Therefore when power is switched on, **Master Tune** will be set to however you last set it, so you don't need to worry about it each time power is switched on.

To adjust master tuning:

1. Press **Master Tune**.

This is found under **PITCH**, on the far right.

The display shows the current master tuning offset from A-440, from -99 to +99 cents. (A cent equals 1/100 of a semitone.)

2. Play a key and use the slider to adjust the value.

By the way, since the Prophet VS uses digital oscillators, they do not drift.

3. To clear the "MASTER TUNE" display, select a program (or any parameter).

KEYBOARD

The keyboard ranges five octaves (61-note: C1 - C6), and is touch-sensitive both to key attack speed (velocity) and after-touch (pressure). Depending on the specific selected program, the keyboard may switch between Single, Split, and Double modes, as described in Section 3.

Modes

The Prophet VS is an eight-voice synthesizer. So, in Single mode you can play and hear up to eight keys at once. In Split mode, you can play four keys on either side, and in Double mode, you can play only four keys, but each key simultaneously plays two programs. An exception to these normal conditions: if **Unison** is on, only one key can be played at a time, but this key can play all eight voices.

Percussion and effects programs sometimes use the keyboard primarily as a triggering device. So it is possible that the keyboard will not be set up for normal polyphonic playing at all.

Position

Of course the position of the key played determines the voice pitch. But it may be less obvious that the key position is also used as a modulation source that can control the oscillator mixture or voice pan position. (This is in addition to its traditional control over filter cutoff tracking.) The key position can have a positive or negative influence over these parameters (except for pitch). For example, as you play ascending scales on the keyboard, the sounds produced can move either from left to right, or from right to left in the stereo image.

Velocity

Velocity-sensitive analog processing allows the oscillator harmonic structure to be intimately controlled by your keyboard technique. Be sure to try various attack velocities (in other words, "key-down" speeds) in different areas of the keyboard. The effect of velocity can change drastically. The graph on the front panel shows the possible destinations for velocity. It can modulate the oscillator mixture, filter or amplifier envelope depth, and the voice pan position within the stereo field (great for many effects).

Velocity modulation is called polyphonic, because up to eight different key velocities can separately and independently modulate the eight individual voices.

Pressure

Like velocity, pressure is a modulation source which can be routed to any destination, and its effect, too, depends upon the selected program. The graph on the front panel shows the destinations for pressure, which includes individual oscillator frequencies, the oscillator mixture, filter cutoff, LFO rate and amount (modulation depth), amplifier level, chorus rate and depth, or voice pan position.

Pressure can be programmed to operate either positively or negatively (for example, either raising or lowering the oscillator pitch). Pressure modulation is called monophonic, because there is

only one pressure signal from the keyboard, which provides the same control effect on all the voices that are being played by the keys currently held.

Note: For more information on modulation, please see Section 10.

WHEELS

The wheels are performance devices which need to be practiced and mastered, just like the keyboard. The Pitch wheel is on the left; the Mod wheel is on the right.

Pitch Wheel and Pitch Wheel Range

The Pitch wheel allows you to play notes "between" the keys. This wheel is double-sprung to automatically return to center. Near the center detent, you may notice a "deadband" of insensitivity to make it easier for you to bend "into" the note.

If you have played other synthesizers, you may already be in the habit of checking the wheel positions each time you play. While this is a good habit to get into, on the Prophet VS it is not strictly necessary. You do not have to check the position of the Pitch wheel, because the springs return it to center position.

Note: During "power-up," do not move the Pitch wheel. When the computer is switched on, it assumes that the Pitch wheel is centered, and takes the current position as the center pitch reference. So if you move the Pitch wheel during power-up, you will be telling the computer to take one of those off-center positions as center pitch, and everything will therefore be detuned until you turn power off and then back on.

The Pitch wheel is monophonic. That is, it affects all the voices uniformly. Except for latched arpeggiator notes, all voices are simultaneously pitch-bent by the same interval.

Pitch Wheel Range adjusts the interval that will be played when the Pitch wheel is rotated fully up or down. You can adjust the maximum range of the Pitch wheel in one-semitone steps. The feel of the wheel is largely a matter of personal taste. The wheel may bend notes up or down by as much as a perfect fifth (covering a range of fifteen semitones). A narrower range gives greater physical control over the bend. In other words, if you set the range to the most "outside" bend you want to make, then you don't have to worry about overshooting it.

Note: Like **Master Tune**, the **Pitch Wheel Range** adjustment is held in non-volatile memory while power is off. Therefore when power is switched on, **Pitch Wheel Range** will be however you last set it, so you don't need to worry about it each time power is switched on.

To adjust the pitch wheel range:

1. Select **Pitch Wheel Range** parameter.

The display shows the current range in semitones, from one semitone to a perfect fifth.

2. To adjust the value, use the **Data Entry** slider.

Mod Wheel

As you play the keyboard, use the Mod wheel to control the depth of low-frequency oscillator (LFO 1 and/or LFO 2) modulation, or depth of the chorus. The Mod wheel is also monophonic; it simultaneously increases the modulation level within all voices.

The Mod wheel is not spring-loaded and does not have a detent. If the Mod wheel is unused, or if it is used and left fully down, minimum modulation occurs.

For more information, see Section 9, which covers the LFOs, and Section 10, which covers the modulation system.

WAVEFORM MIX JOYSTICK

During performance you can use the joystick to modulate the mixture of the four oscillators in the current program. This enables you to spontaneously and dynamically modulate the timbre by reshaping complex waveforms or introducing detunings. This real-time modulation occurs in addition to the programmed action of the mixer envelope generator and other mixture modulators.

Explore the effect of fast or slow movement throughout the joystick range.

CHORUS LEFT/RIGHT

The stereo chorus circuit (analog delay line) enriches the sound and can be switched on and off independently for either output channel. This is handy for stereo effects, as well as Split or Double modes where you might not want both programs to be chorused.

ALTERNATE RELEASE FOOTSWITCH

The **ALTERNATE RELEASE** footswitch is usually programmed to simulate the action of a piano's sustain pedal. It does this by switching between two rate values for the envelope generator release

stages (rates 4 and 4A). When the footswitch is disconnected or up, releasing a key engages the original (and usually shorter) rate 4. When the footswitch is connected and held down, this selects the alternate release value 4A (for all three envelope generators), which is usually programmed to be noticeably slower (longer) than the original release rate.

AUX FOOTSWITCH

The AUX footswitch is used exclusively for real-time control over the arpeggiator. If the footswitch is pressed while arpeggiating, notes are latched into a "sequence" which can be recalled for playback later.

SECTION 3

PROGRAMMING

INTRODUCTION

In the Prophet VS, responsive physical controllers--key position, velocity and pressure, the wheels and joystick--combine with an entirely new approach to timbre generation, to create a performance synthesizer with unrivalled sonic power and variety, and which also happens to be very easy to program yourself.

This section explains how to select, edit and store programs. Specific operations and adjustment procedures for each module are detailed in following sections.

MEMORY BASICS

To correctly store your programs and use cartridges, you need to know a little bit about the Prophet VS memory system.

Internal Memory

The Prophet VS has two different kinds of internal memory. If the information can be changed by the player, it is stored in non-volatile random-access memory (RAM). The term "non-volatile" means that the contents of this memory are not lost when power is switched off. (This is because of an internal battery with a very long life span.) If the information is of a permanent nature and cannot be changed by the player, it is stored in permanent read-only memory (ROM).

There are several types of information in memory, and some information may be stored in either RAM or ROM:

The operating system contains the instructions that make the Prophet VS run. All of the operating system is in ROM.

Waveforms are the basic elements of each sound program. RAM

can hold 32 waveforms, and ROM contains 96 waveforms. You select a RAM or ROM waveform according to the wave number: RAM waves are numbered 00-31, ROM waves are numbered 32-127.

Programs are the set of selected waveforms, synthesizer voice and modulation settings, and keyboard configuration (Normal, Split, or Double) which comprise a sound. All 100 internal programs are in RAM.

Cartridge Memory

The cartridge system allows you to have virtually instantaneous access to any program in your sound library. It has its own switch. When **Cartridge** is off, only internal data is used. When **Cartridge** is on, program or wave selections, or storage, are made to the cartridge instead. Cartridge programs still use the VS's internal ROM waveforms (#32-127). It is easy to copy individual programs between internal memory and the cartridge.

Two types of external memory cartridges can be used: Model 240 VSRAM cartridges and Model 241 VSROM cartridges.

For best cartridge performance minimize contact with dirt, liquids, temperature extremes, and direct sunlight.

Model 240 VSRAM Cartridge

RAM cartridges contain 100 programs plus 32 waveforms. In other words, the RAM cartridge provides a complete duplication of the internal RAM. RAM cartridges are, of course, non-volatile. They can provide a complete backup of the RAM, but more importantly give you the ability to build up a vast library of custom programs.

RAM cartridges shipped from the factory have 100 blank programs and 32 blank waveforms which you can replace with your own. For protection, a **Store** (write protect) switch ensures that programs on RAM cartridge can not be lost unless you choose to erase them.

Model 241 VSROM Cartridge

ROM cartridges contain 100 factory-programmed, permanent programs. These programs use only the waveforms which are in internal ROM (#32-127). They do not use any waveforms in RAM (#00-31).

While the ROM cartridge is installed, you can still access any waveforms or programs in RAM, or copy a program from the ROM cartridge into a RAM location, for editing. If desired, you can replace the ROM cartridge with a RAM cartridge, and then save the program to that.

PROGRAM EDIT MODE

When you first select a program, all parameters are set as the program dictates. For performing, you can't beat this programmability for simple and powerful control.

And while you can rely on the factory programs, at some point you probably will also want to learn how to make your own programs. The way to begin doing this is to simply start adjusting the controls and see what happens. The Prophet VS is normally in Program Edit mode. As you adjust the controls to modify the sound, you are said to be "editing" the current program. The term "edit" is used because you are actually making changes to computer data in RAM. The computer system uses this data to determine how the Prophet VS responds when that program is selected.

The edits you make are temporary, and do not affect the memory of the current program until and unless you specifically store the edited program over the original. If you do not want to lose the original program, but need to store the edited program, you must store at -- and erase-- another program location.

Your main editing tool, of course, is the 16-character by two-line, back-lit, liquid crystal display (LCD). It displays program numbers and names, parameter names and values, and, when necessary, prompts you to perform an action such as pressing the **Enter** switch, or the keyboard. (The **Enter** switch is not used very often.)

If the VS is not used for more than five minutes, the display lighting switches off.

Within the LCD, a cursor appears as a blinking one-character underline. When a switch for a control group is pressed, the cursor advances to the corresponding function.

The **Data Entry** slider selects values or alphanumeric characters for the parameter at which the cursor is located.

One of the best routes into the Prophet VS is to find a factory program you like, and use it as a study example accompanying the sections which follow this one. You should be able to learn a lot by selecting and displaying the parameter values, reading in this manual about what they mean and what you can do with each, and then diving right in and changing them to see what happens. Editing existing programs is the quickest way to begin to create your own presets. Don't be afraid to experiment with the parameters: you cannot break the computer (except by physical force), and you can always restore the original program (as long as you don't accidentally store over it).

In general, this is how you edit:

1. Select the desired program, as displayed in the **Program** LED display.

2. Select the desired parameter using the control switches.

The switches give you immediate access to any parameter. The display changes as required, and the cursor moves to the correct place in the display, showing the current value of the selected parameter.

3. Using the slider, adjust parameter value as desired.

When the parameter is first selected, the display shows the previous or current value. If desired, note this value before moving the slider, because moving the slider causes the value to jump to the value represented by the slider's current position.

The range of the slider changes with the selected parameter. The format and purpose of the display also change according to the parameter. Sometimes the value adjustment displays numbers, and other times it displays words or messages.

The digital parameter readout is convenient both for precision setting and repeatability. However, the easiest way to get a comprehensive view of the program is probably to use the definition forms provided at the back of the manual.

In many cases (but not all), to hear the effect of edit changes you must re-strike the key.

4. If desired, select and adjust other parameters.

If a program has been edited, whenever the LED switches (except **CHORUS Left** and **Right**) are deactivated, the display says "editing (name)" in the bottom line. This tells you that the current program has been edited, even though no specific control is now active.

5. To cancel all edit changes and restore the original, unedited program, simply re-select the desired program number.
6. Otherwise, you can permanently record the current edition of this program by storing as explained under the next heading.

STORING PROGRAMS

There are basically three things you can do with an edited program. First, if you don't like it, you can get rid of it and return to the original program, by simply re-selecting the original program. (Or, of course, you can select any other program.)

Second, if you prefer the edited program to the original, you can store it in place of the original. Third, if you want to retain the original program, you will want to store the program over an undesired program.

Therefore before storing a program it is a good idea to make sure that the internal or cartridge destination program number you have in mind is in fact undesired. To help avoid accidentally erasing valuable programs, the Prophet VS has separate Review and Store functions.

Review

Use this function before storing a new or edited program.

Review assists you in finding a destination for your edited program by allowing you to temporarily save the current edited program so that you can compare it to other programs.

1. To begin with, you have an edited program, and the **Store** and **Edit Waveform** switches are off.
2. Switch **Review** on, as indicated by its LED.

This "freezes" the current edits and holds them in a temporary RAM location. When **Review** is on, this means that an edited program is being held in temporary storage. In other words, when you switch **Review** off, your edited program is still there.

3. To review programs, enter the desired two digits.

The **Program** display shows the number of the program being reviewed. This program is heard instead of the edited program.

It is true that you cannot record over cartridge ROM programs but you are allowed to review them for comparison purposes.

4. To hear the edited program again, switch **Review** off.

Your edited program returns. Note that for convenience the **Program** display retains the number of the last program reviewed.

5. If desired, store the edited program at a suitable program number. (See below.)

Store

To store an edited program:

1. Decide the destination. (Use **Review**, see above.)
2. If the destination is internal, switch **Cartridge** off.
3. If the destination is external, switch **Cartridge** on and insert a RAM cartridge.
4. Make sure that the cartridge **Store** switch is set to En.

5. **Review** and **Edit Waveform** must be off.

6. To store, switch **Store** on.

Its LED lights.

This prepares the Prophet VS to store the edited program.

The display will say "STORE PROGRAM TO" the current destination, internal or cartridge.

7. If you decide you do not want to store the program, this is your chance to exit the procedure by simply switching **Store** off.

8. Enter two digits for the storage destination. The program will be stored when you enter the second digit.

If **Cartridge** is on and a ROM cartridge is mistakenly in place, it will ask you to insert a RAM cartridge. After doing that, re-enter the two digits.

When stored, the screen returns to the main message:

PROGRAM #/xx name

The new program now appears under the selected number.

9. If desired, protect the cartridge again by setting its **Store** switch to "Dis."

TRANSFERRING PROGRAMS AND WAVEFORMS

For back-up purposes, storing and re-loading programs on cartridge one at a time is too time-consuming. Instead the VS allows you to store or load its entire memory in one operation. Of course, after such operations, the VS or RAM cartridge's previous contents are erased, so make sure you are not loading over valuable programs or waveforms before using any of these operations.

Dump Internal to Cartridge

To store all one hundred programs, or all thirty-two RAM waveforms on cartridge at once:

1. Switch **Store** on.
2. Switch the cartridge **Store** switch to "Enable."
3. Switch **Cartridge** on.

4. Adjust the slider so the display reads:

COPY ALL PROGS or COPY ALL WAVES
TO CART (enter) TO CART (enter)

5. Press **Enter**.

The cartridge's programs or waveforms are replaced by the VS's current memory.

Load Internal from Cartridge

To load one hundred programs or thirty-two waveforms from cartridge:

1. Switch **Store** on.
2. Switch **Cartridge** off.
3. Adjust the slider so the display reads:

COPY ALL PROGS or COPY ALL WAVES
TO INT. (enter) TO INT. (enter)

4. Press **Enter**.

The VS's internal programs or RAM waveforms are replaced with the cartridge's current contents.

NAMING PROGRAMS

A program can have an eight-character name. When you store an edited program, it keeps the name of the program from which it was derived until you change it. The name can be changed at any time the program is selected. But like any edit, to be retained, name changes must be specifically stored.

To write a program name for the current program:

1. Press **Name**.
2. Select the first character, using the slider.

The range of characters are A-Z (ALL CAPITALS), numbers 1 - 5, and a blank space.

3. To move to the next character position, press **Name**.
4. If desired, store the program with the new name.

PROGRAM EDIT, REVIEW, AND STORE EXAMPLE

The following example does not affect any programs in memory. Only the program name is changed, and if desired, the new name can be the same as the original.

1. Select a program.

2. Press **Name**.

The first character of the current name is underlined.

3. Change the underlined character with the slider.

4. Press **Name**.

The next character is underlined.

5. Repeat these two steps until the new name is entered.

6. Before saving the program, check that the "new" program sounds the same as the original by pressing **Review**, then playing the keyboard.

The original program name is displayed. The original program sounds no different from edited version.

7. When done reviewing, switch **Review** off.

8. To store the program, switch **Store** on and enter the two-digit program number chosen with the Review function.

RANDOM PROGRAM CREATION

This unique feature generates sets of random parameter values. Although few programs will be usable without modification, they may serve well as starting points for creating new programs. Many random programs demonstrate the effects of unusual combinations of the VS' features which you may not otherwise consider trying. Generating random programs is certainly an effective way to overcome "programmer's block."

Random programs are actually edits to the current program, and, like any other edited program, to be remembered, must be stored intentionally.

To create a random program:

1. Select any program.

2. Hold down **Enter**, then press **2**.

This gives random values to all program parameters, from the mixer envelope to the program name. (For a higher percentage of useful programs, the VS avoids certain combinations of parameters.)

3. Play the keyboard.

Also be sure to check the effect of moving the joystick or Mod wheel.

4. If the random program shows little promise, generate other random programs until a better one appears.

5. If desired, edit and store the program.

The practice of trying to edit random programs for the best effect will be a great way to learn how to program the VS.

SECTION 4

KEYBOARD MODES

SINGLE MODE

Normally the keyboard is a unified instrument (such as a piano), allowing you to play up to eight keys at once. The keyboard normally operates in multiple-trigger mode: pressing any key triggers a new envelope. If all eight voices are being used, the most recently-played key generally "steals" the voice it needs from the oldest note. For example, if you play and hold eight keys from C to C, when you play the ninth key, the first key that you pressed will disappear.

If **Unison/Detune** is on, all eight voices are assigned to the last key played, for a "fat" sound.

LINKING PROGRAMS

Often it is useful to be able to play two distinct sounds simultaneously (such as brass and strings). To accomplish this, each current program has another program "linked" to it. The linked program can either be 1) not heard at all; 2) played from the lower octaves of the VS, with the current program played over the higher octaves; or 3) played across the entire keyboard at the same time as the main program. These three configurations --the "Keyboard Modes"-- are called "Single," "Split," and "Double."

SPLIT MODE

Split mode divides the keyboard into left and right sections at a variable split point (which is set as discussed below). The right section (from the split point to the top C key) plays the current program. The left section (between bottom C and the split point) plays the linked program. Split mode limits you to four voices

available for each side, unless **Unison/Detune** is on, in which case all four voices on the side are assigned to the same key.

To set up Split mode:

1. Select the desired program number for the right side.
2. Switch **Split** on, as indicated by its LED.

The LCD shows the linked program, and split point.

The program on the left side is linked to the current selection by the **Link Select** function (see below).

The LCD shows the name of the current split key, which is the lowest key on the right side. There are six Cs on the keyboard, and they are numbered 1 through 6. The first octave consists of notes C1 through B1, the second octave is C2 through B2, and so on. The fifth octave is C5 through B5, and C6 is by itself.

3. To change the linked program, press **Link Select**, then adjust the slider for the desired number.

Of course, you can play the keyboard to hear the left program.

4. If you want to change the split point, switch **Split** off, then on again, holding it down so that the display reads "(Press new key)", then press the key which is to become the new split point.

You can change your mind. As long as **Split** is lit and held down, you can change the split point. The name of the last key pressed appears in the display as the split point.

5. If desired, store these changes with the current program.

From now on, whenever you select this program, Split mode will automatically be on, with the split point and linked program you just selected. Even if **Split** is later switched off, these parameters will be remembered.

Note: Because of the pan-modulation system, selecting left and right programs is not sufficient to ensure that the programs appear strictly in the left and right audio output channels. If you want four voices to be hard left and four hard right, unless you have edited a program which already has the desired voice positions, you may have to check the **Voice Pan** control. (See Section 11.)

DOUBLE MODE

When **Double** is on, the current and linked programs are layered in the vertical dimension so that one key simultaneously plays two programs. As with **Split** mode, voice stealing also occurs after four keys are held. If **Unison/Detune** is on in both programs, all 32 oscillators can be played by one key.

In addition to the interest created by doubled programs, this mode can be used to perform velocity or pressure-controlled mixing of the two programs. To do this, in one program positive modulation is used and in the other negative modulation amounts are used. (See Section 10.)

Furthermore, this mode allows you to detune or delay the linked program relative to the current program. Since programs can be linked to themselves, this allows for effects ranging from chorus to echo.

To set up Double mode:

1. Select the desired program number.

This program will be the current program, in other words, the linked program will be detuned or delayed relative to this program. The voice output locations will depend on the **Voice Pan** and **Modulation** controls.

2. Switch **Double** on, as indicated by its LED.

The display shows the current detune value and linked program number.

3. To select the linked program, press **Link Select**.

The LCD cursor underlines the current link number.

4. Select the desired program number with the slider.

To hear the programs together, play the keyboard.

5. If desired, press **Link Select** to select **DETUNE** and adjust for desired detuning of the linked program from 0 to 31 cents.

Note that there are two separate detuning functions: this one (Double mode), and **Unison/Detune** mode, which is covered in Section 11. If a program is detuned in **Unison** mode, it can be further detuned using **Double** mode. In other words, detuning adds together.

6. If desired, press **Link Select** to select **DELAY**, and then adjust slider for the desired delay of the linked program, from 0 - 500 msec.

With short delay times similar programs may sound flanged. If the delay is lengthened, thickening, chorus, and echo effects can be created. There are many interesting interactions available between detuning and delay.

7. Store this edited program.

From now on, whenever you select this program, Double mode will automatically be on, with the detuning, delay, and linked program you just selected.

SECTION 5

ARPEGGIATOR

ARPEGGIATOR BASICS

Here is a fully-programmable, multi-featured arpeggiator, which can be used for lots of tricks. The VS arpeggiator differs from most arpeggiators in that it allows you to overdub a second arpeggiation. This feature, combined with an easy method for inserting rests between notes, allows complex note patterns to be created which resemble single-step sequences, yet are of a more spontaneous nature and tend to be less static.

These arpeggiated patterns are referred to as "sequences" in this manual due to the VS' ability to hold latched notes in memory when power is switched off.

Most parameters are adjusted through the **Arpeggiator Option Select** control, and saved along with sound parameters as part of each program.

Since all programs have arpeggiator settings, first try some of the factory programs before programming the arpeggiator.

1. Select the desired program.
2. Switch **On-Off/Rate** on.

The main arpeggiator display appears:

```
ARPEGGIATOR  
RATE: XX (depends on program)
```

3. Hold down some keys.

The VS plays the notes.

In some programs, you must continue to hold keys for the arpeggiator to run, in other programs, the arpeggiator automatically latches the notes. (See below.)

4. Adjust the arpeggiator rate with the slider.

The rate is adjustable from 1-99, or can be set to synchronize to MIDI clocks received from external MIDI equipment.

If the rate does not go slow enough for your taste, don't worry. The rate value interacts with the CLOCKS/STEP option (described later in this section).

5. Press **Latch/Transpose**.

6. Release all keys.

The arpeggiator continues.

7. If desired, play the keyboard while the arpeggiator is latched.

Depending on the program you initially selected, the keys you play may or may not be arpeggiated. (More on this later.)

Using the Pitch wheel while the arpeggiator runs has no effect on the arpeggiated notes. If you use the Pitch wheel while the arpeggiator is latched --and no longer arpeggiating what you play--then the notes played live are pitch-bent, but the latched notes are not. If you use the Mod wheel, all notes --played or latched--are affected.

8. If desired, select other programs while the latched sequence runs.

9. Hold down **Latch/Transpose**, then play a key.

The sequence transposes to a new key (relative to middle C). For example, to transpose up a fifth, press G3. To return to the original key, press C3.

10. To stop, switch **On-Off/Rate** off.

11. To play back the sequence, press **Latch/Transpose**.

Note: The sequence is stored in the VS' memory, and will be remembered when power is switched off. Only one sequence can be stored in the VS at a time.

The VS' arpeggiator treats notes received over MIDI as it does notes played on the VS itself. MIDI options affecting the arpeggiator are explained in Section 14.

ON-OFF/RATE

This switch prepares the arpeggiator for new notes. When pressed, the previous latched arpeggiation (sequence) is erased, and the LCD shows the current rate. Whenever this main display appears in the LCD, the slider controls the rate from 1-99, or for external clocking.

Each program has its own programmed arpeggiator rate. As with any program parameter, the rate must be stored with a program for it to be retained in memory for future use.

Of course, no notes are arpeggiated until some keys are played, so unless you happen to know that the programmed rate is suitable, you will want to adjust the rate as you play.

If you select any other program parameters while the arpeggiator is running, to return to the "rate" display (without stopping the arpeggiator), press **Enter**.

The rate is variable over a range determined by the CLOCKS/STEP option. The VS is shipped with CLOCKS/STEP set to 6 when shipped from the factory. This provides for easy interfacing with most MIDI clocking devices (drum machines, sequencers). The arpeggiator's rate ranges from .4 to 70 steps per second.

Note that if the arpeggiator rate has been programmed to a low value, the keyboard will appear to respond very slowly to playing.

LATCH/TRANPOSE

This is used to latch an arpeggiation. Once latched, the notes are remembered when power is switched off. **Latch/Transpose** is also used to start playback of the last latched sequence.

1. To manually "latch" the arpeggiator, hold keys and press **Latch/Transpose** or the AUX footswitch, then release keys.
2. To switch off, press **On-Off/Rate**.

If Auto Latch or Extend arpeggiator transpose modes have been programmed on, holding a key or keys for one complete loop of the arpeggiator sequence is sufficient to latch the key. Autolatch sequences are created and ended by holding one key. Extend sequences accept up to about 120 notes, until the arpeggiator is switched off.

Once a sequence has been latched, it is possible to create a second sequence if the LAYER option is on (see below).

Latch/Transpose can not latch an overdubbed arpeggiation ("layer"). These can only be latched automatically in Autolatch or Extend arpeggiator modes (see ARPEGGIATOR OPTIONS).

If the current program is different from the one selected before latching the arpeggiator, the sequence may not start, because some of the arpeggiator options are different in the new program. The sequence is still there however, and can be played back with the original program, or one with compatible arpeggiator options.

Transposing

Once an arpeggiator sequence has been latched, it can be transposed:

1. Hold down **Latch/Transpose** or the **AUX** footswitch.
2. Press a key on the keyboard.

Transpose keys are relative to Middle C (C3). For example, to transpose an octave up, press C4. To transpose a fifth downwards, press F2.

ARPEGGIATOR OPTION SELECT

There are ten options which affect the operation of the arpeggiator. Nine of these are stored as part of each VS program. The tenth option --CLOCKS/STEP-- affects the operation of the arpeggiator in all programs.

To adjust the current program's arpeggiator options:

1. Press **Option Select**.

The display shows the status of the default arpeggiator option.

2. To step through the options, press **Option Select** until the desired option is displayed.
3. To adjust any displayed option, use the slider.

Each option is described in detail below.

Arpeggiator Modes

The arpeggiator mode determines how notes are arpeggiated. There are three modes:

Normal Mode

Allows only keys held down to be arpeggiated.

Auto-latch Mode

Auto Latch remembers all keys that were pressed as long as at least one key is held down. If all keys are released, then the arpeggiation continues. A new arpeggiation is started with the new keys.

Extend Mode

Extend adds keys as you play them. To add notes into the sequence, play the desired keys. Allows up to about 120 keys to be remembered in the current arpeggiation sequence. Switching the arpeggiator off cancels the current arpeggiation (unless it is latched manually with **Latch/Transpose**). Since the keys are played in the order they are entered, amazing solos can be set-up and run predictably.

Note: Recorded sequences can be played back in the same mode as they were recorded. If you change mode while the arpeggiator runs, notes are temporarily unlatched. (Switching back to the proper mode revives the sequence.) This is why changing programs can prevent a sequence from being played back.

Scan

The order in which notes are played by the arpeggiator is determined by the SCAN option. There are six possible SCAN settings:

UP

Keys are sequenced from lowest to highest.

DOWN

Keys are sequenced from highest to lowest.

UP/DOWN

Keys are sequenced from lowest to highest, back down to lowest.

ASSIGN

In this mode, keys are sequenced in the order you press them.

REVERSE

Notes are played in the reverse order they were played.

RANDOM

Keys are randomly sequenced.

Note: The SCAN setting can be changed after latching notes. All notes latched or overdubbed will be played according to the new setting.

Octaves

The arpeggiator can repeat sequences over a range of two, three, or four octaves above the original notes.

The notes of the upper octaves become part of the arpeggiator sequence. Note that the arpeggiator plays keys just as if you were playing them on the keyboard. The sounds produced are exactly the same as if you played those keys. This may cause the arpeggiator to play undesired keys above a split point.

Repeats

The arpeggiator can play each note up to four times before playing the next note.

When the REPEATS option is selected, adjust the displayed value to the desired number of times you want each note to play. For example, a value of 2 makes each note play twice.

There is lots of opportunity for interesting effects here. Try using Double keyboard mode with various delay values with this as well.

Split

This option lets you arpeggiate one side of the keyboard while playing the other, or arpeggiate both keyboard sides simultaneously. This option is only effective with split programs. (Remember that programs can be linked to themselves, so it is not necessary to split the keyboard with two different programs.)

SPLIT can be changed any time without affecting notes already arpeggiated.

1. Select the desired split program.
2. Press **Arpeggiator Option Select** until the SPLIT display appears.
3. Adjust to the desired setting.

There are four arpeggiator SPLIT settings:

OFF

The arpeggiator ignores the split point, and arpeggiates the keyboard as a whole.

RIGHT

Only keys to the right of the split point are arpeggiated. The left section of the keyboard plays normally.

LEFT

Only keys to the left of the split point are arpeggiated. The right section of the keyboard plays normally.

Note: If OCTAVES is set to 2 or 3, the arpeggiator may steal voices from the right side of the keyboard, but not play them with the left (linked) program.

DUAL

When SPLIT is set to DUAL, keys below the split point are arpeggiated separately from keys above the split point, producing two "layered" sequences which play simultaneously.

Note: If you latch such a sequence, you will not be able to overdub later.

Voicing

This option can be adjusted at any time, and affects playback only. There are two settings:

MONO

The VS plays arpeggiated notes in the manner of a monophonic synthesizer. One voice only is assigned to each layer of the arpeggiator, and is retriggered at the start of each note. This is useful with short percussive sounds. Unison programs will not sound as full when arpeggiated with monophonic voicing, but can be layered over with remaining voices.

POLY

Arpeggiated notes are assigned to the VS' voices as if they were being played live. This setting is recommended for programs with long "release" times (rate 4/4A).

Velocity

With this option you can choose to have the arpeggiator record all notes with equal velocity (VELOCITY off), or with the velocity with which they were originally played (VELOCITY on).

Layer

This option lets you overdub a second arpeggiation over a latched arpeggiator sequence.

1. Switch **On-Off/Rate** on, hold some notes, then press **Latch/Transpose** to latch them into the sequence.
2. Press **Arpeggiator Option Select** until the LAYER display appears.
3. Set LAYER to "ON" with the slider.
4. Hold down some other keys.

The new keys are arpeggiated while the first arpeggiator sequence continues unaffected. If the two arpeggiations are of different lengths, interesting note patterns occur which do not repeat as often as either of the two individual sequences.

5. When finished overdubbing, switch LAYER off with the slider.

Any keys played are no longer arpeggiated. LAYER can be switched on/off as many times as desired.

Note: If the arpeggiator mode is set to **AUTO LATCH** or **EXTEND**, the overdubbed notes are remembered when the arpeggiator is stopped.

Rests

This option lets you insert rests in arpeggiation for syncopation. When the **RESTS** option is set to "on", the top C on the VS keyboard is interpreted by the arpeggiator as a rest. If the top C is needed in an arpeggiation, simply set **RESTS** to "off".

If the arpeggiator split option is set to "DUAL" (left and right sides of the keyboard arpeggiate separately), then the lowest C becomes the "rest key" for the left arpeggiator, and top C becomes the "rest key" for the right arpeggiator. This allows both arpeggiations to contain rests.

RESTS can be switched on/off at any time, as needed.

Clocks/Step

This option can be thought of as a "coarse" control for the arpeggiator rate. The **CLOCKS/STEP** value determines the number of internal or external clocks needed to step the arpeggiator. The arpeggiator rate is still adjusted from the main arpeggiator display, but the range changes. The higher the **CLOCKS/STEP** setting, the slower the arpeggiator rate range.

When clocking the arpeggiator over MIDI, set CLOCKS/STEP to match the 24 clocks per quarter-note rate of the incoming MIDI clock. (See Section 14.) The VS comes from the factory with the required CLOCKS/STEP setting of "6" (corresponding to sixteenth-notes when clocked over MIDI).

Note: CLOCKS/STEP is not programmable per program. Its setting affects all programs, and is remembered when power is switched off.

SECTION 6

OSCILLATORS

OVERALL SIGNAL FLOW

Figure 6-1 (next page) shows a general block diagram of the overall signal flow in one voice of the Prophet VS. A "voice" is a sound producer, such as a singer in a choir or an instrument in an ensemble. While we often speak in terms of a single voice, it is important to remember that the Prophet VS actually has eight voices--which is why you can play up to eight keys at once. When the keyboard is in normal mode (not Split or Double), the basic parameters of all eight voices are programmed identically, so that each voice produces the same sound or effect. The differences between the voices basically depend on only two things: the position of the key played (which changes the pitch of the voice), and the playing velocity (which usually affects the loudness or effective envelope depth).

The Prophet VS's voice modules are laid out similarly to a standard voltage-controlled analog synthesizer, such as the Prophet-5. Technically, like all Prophets, the Prophet VS is a hybrid synthesizer. This means that both digital and analog techniques are employed to create the sound. As the Prophet line has developed, functions that were originally handled by voltage-controlled analog hardware, and which are generally drawn in analog form on block diagrams, have been gradually converted to computer software. For example, the envelope generators and low-frequency oscillators (LFOs) in the Prophet-600 and -T8 were actually in software. And in the Prophet-2000, the voltage-controlled analog oscillators were replaced by a programmable sample memory. In the Prophet VS, the most dramatic changes have occurred in the oscillator and modulation modules, which, too, are now based in digital hardware and software.

In previous performance synthesizers, the oscillators have usually been set up to provide only basic, raw timbre material. The means for modulating the oscillator waveform itself has often been limited to pulse-width modulation and swept-sync effects (such as are available through the Prophet-5's Poly-Mod section). This has meant that the waveform from the mixer has been relatively static and the actual synthesis has largely depended on the filter and amplifier modules as modulated by the envelopes and other modulators.

However, in the Prophet VS the oscillator module itself is capable of producing new, interesting, and lively timbres. Instead of voltage-controlled oscillators, the Prophet VS uses digitally-generated oscillators which can use any waveform stored in its memory.

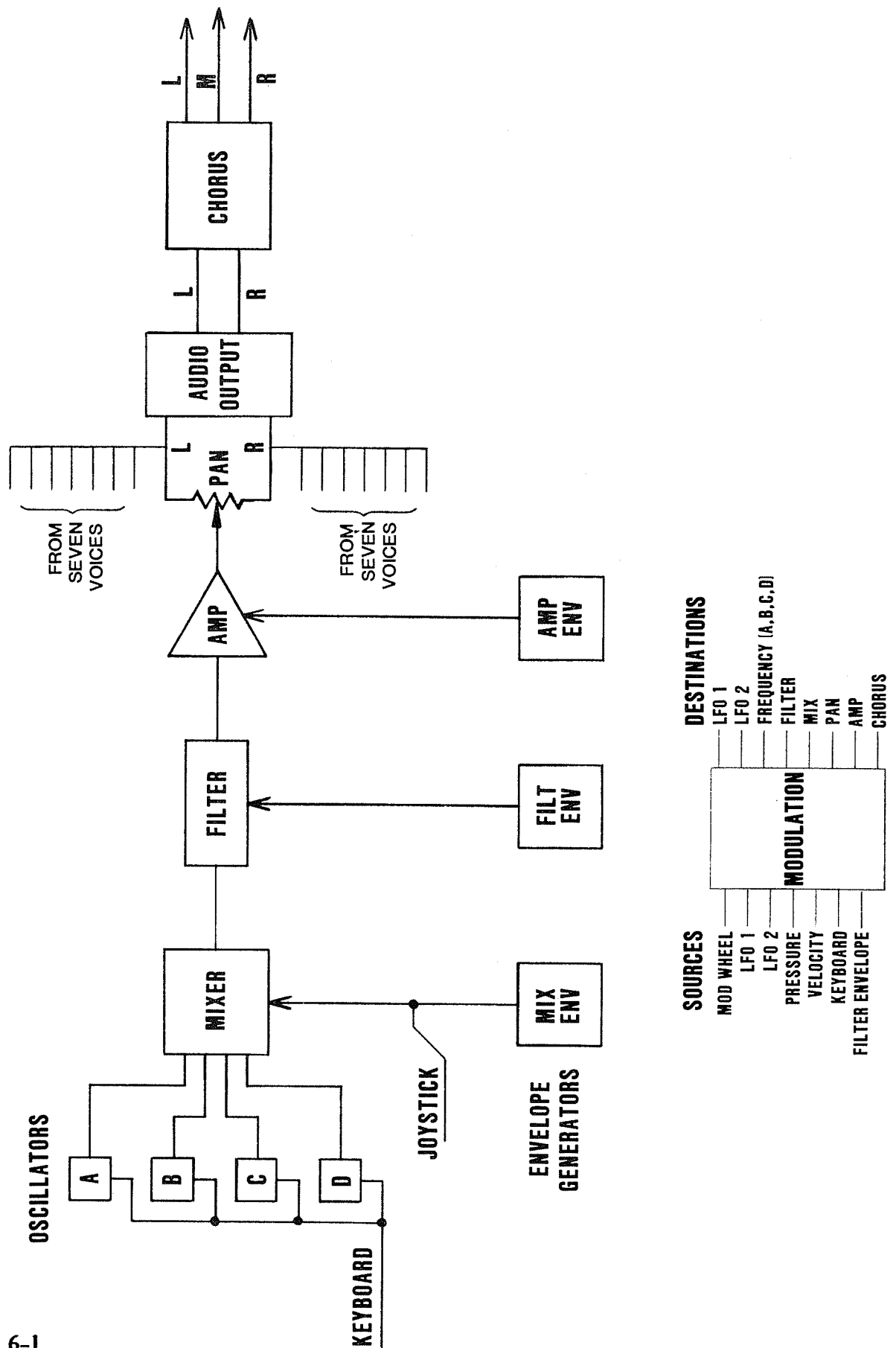

Figure 6-1
GENERAL BLOCK DIAGRAM

This approach allows these oscillators to assume a much larger role in the synthesis due to the specific way that the waveforms in computer memory can be selected, modified, and precisely mixed in "real" time (that is, as you play). (This actually occurs with the assistance of some special, Sequential-designed integrated circuits.)

Referring to Figure 6-1, there are four oscillators in the voice. The pitches of all four oscillators "track" the keyboard. The oscillators produce four separate, continuous tones, which are combined into one signal by the oscillator mixer. There are two ways to adjust the mixture of the four oscillators while the note is being played: physically, using the joystick; or electronically, using the mixer envelope generator or other modulation sources. Although the mixer system is conceptually very simple, it is capable of producing extremely complex timbres as either the joystick or modulators vary the mixture dynamically. This is the essence of "Vector Synthesis."

The oscillator mixture goes to the characteristic Prophet low-pass filter which can shape the timbre in traditional analog fashion, as driven by its own envelope generator. The voice dynamics are then shaped by the amplifier, which also has its own envelope generator. The output of the voice can be sent to either the left or right audio output channel, along with that of the seven other voices. The voice position within the stereo field can be modulated in a variety of ways.

The three envelope generators are far more flexible than the traditional ADSR devices. And there are a number of other modulation sources, both physical and electronic, which can further enliven the sound through a variety of techniques.

The Prophet VS's modulation section has also been greatly enhanced by the flexibility which software allows. It provides over 40 different modulation routings within the voice, but they are all easily controlled by just one source switch and one destination switch.

With this overall view in mind, we can now look at the modules in more detail. The manual sections correspond exactly to the front panel parameter groups.

OSCILLATOR BASICS

As mentioned in the general discussion, the origin of sound in the Prophet VS voice are the four oscillators, named Oscillator A, B, C, and D. Using four oscillators per voice provides a rich foundation as well as a broad selection of basic timbres. All oscillators are completely independent: there is no synchronization between them. And since there are eight voices, the Prophet VS actually contains 32 oscillators in total.

The two most important attributes of an oscillator are its frequency and its waveform. In the Prophet VS each oscillator actually has a

number of sources of frequency control. Figure 6-2 shows three types of oscillator frequency controls:

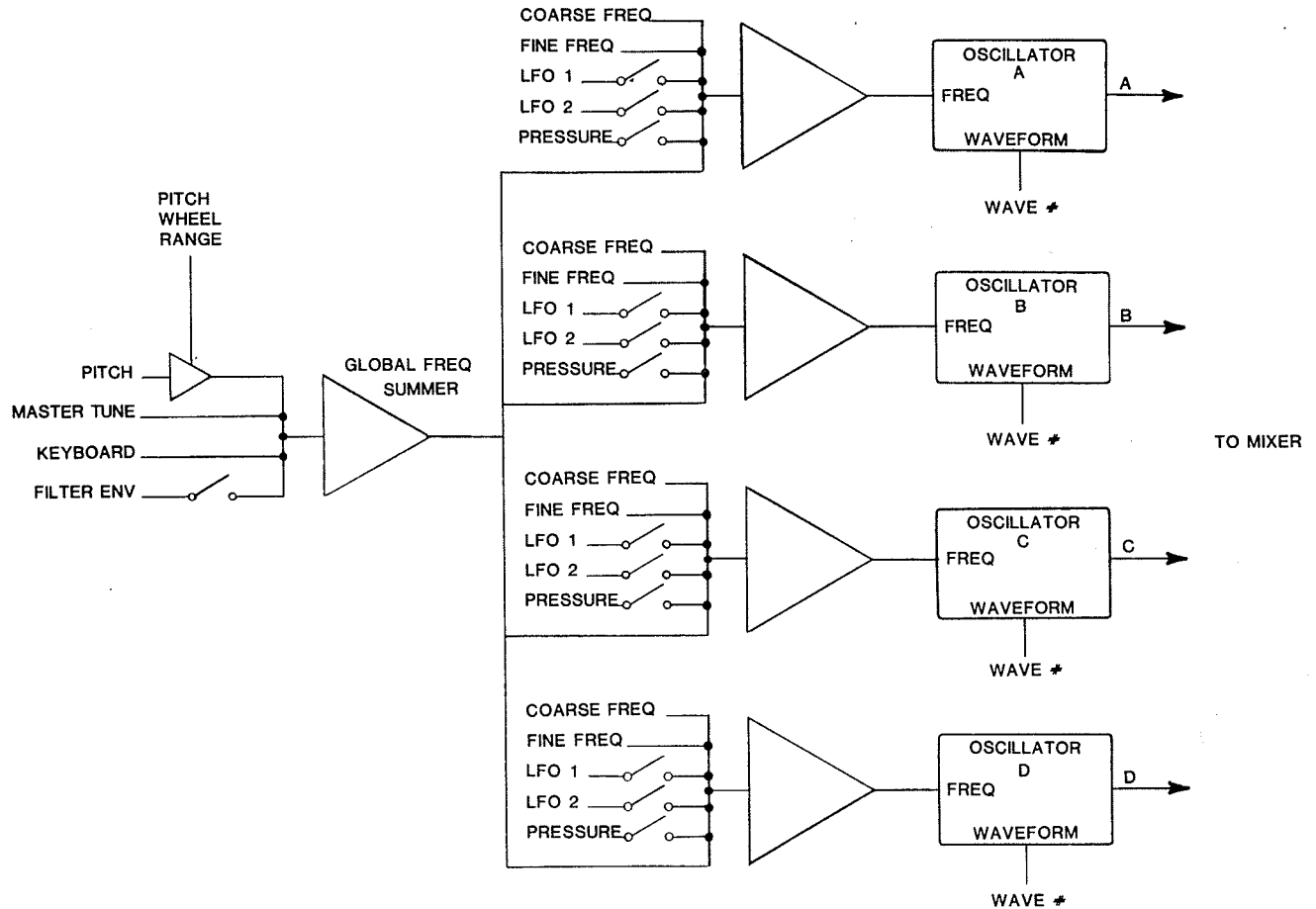

Figure 6-2
OSCILLATOR FREQUENCY CONTROL

The first type raises or lowers the pitch of all oscillators in all voices: for example, **Master Tune** and the Pitch wheel.

The second type of frequency control affects each voice independently. The keyboard signal corresponding to the position of the key being played controls all four oscillators in the voice at the same time (as discussed above). Also, if on, the filter envelope modulation source can also drive the voice pitch sharp or flat.

The third type of control affects each oscillator for completely independent oscillator tuning or detuning within the voice itself, each oscillator has its own coarse and fine initial frequency controls (or offsets), and can be separately modulated by either or both LFOs, and pressure. This makes possible a wide spectrum of dynamic pitch-shifting techniques.

In addition to this highly-versatile frequency control system, the main difference between these oscillators and those of previous Prophets is that the waveforms of these digital oscillators are held in computer memory. (The memory system was discussed in Section 3.) Up to 128 different waveforms can be selected for each oscillator. (This compares with three basic waveform shapes available on a standard analog synthesizer.) Waveforms are selected from either RAM (00-31) or ROM (32-127).

The importance of the waveforms is that the specific shape of the oscillator wave, of course, determines its harmonic content, which in turn is perceived as timbre. When two waveforms are combined, a new waveform is created, which will have a timbre all of its own. In the Prophet VS, new timbres can be created by mixing up to four waveshapes together.

OSCILLATOR MIXER

Given four oscillators, what do you do with them? How do you control them so that they are easy to set up, yet flexible enough to allow new and complex uses? For example, if you have just two oscillators, you can control the mixture between them with one knob (as on the Prophet-600). But for three or four oscillators, three or four level knobs are usually needed. Certainly, requiring four knobs to adjust a timbre is cumbersome at best. Furthermore, if you wanted to change the oscillator mixture dynamically (quickly, in real-time), the traditional analog answer would require four envelope generators--for a total of at least 20 interacting controls. While such synthesizer "patches" are suitable for users of large, modular systems--who also happen to have a lot of spare time--they are far too impractical for today's performers.

And, it turns out, such complexity is unnecessary. To exploit the sonic power of four oscillators, Sequential engineers turned to the basic concepts of analytic geometry and found a very elegant solution in the Cartesian coordinate system. By assigning an oscillator to each of the four poles, a single point can simultaneously represent the mixture level for all four oscillators. For example, if the mixture point is exactly in the center (at the "origin"), you have an equal mixture of all four oscillators. Of course as the mixture point moves away from center, the oscillator(s) towards which it heads become louder and the oscillator(s) it moves away from get softer.

The basic way to move the oscillator mixer point is with the **Waveform Mix** joystick. Please see Figure 6-3 (next page). One dimension of the mixer (the "A-C axis"), is the blend of oscillators A and C, and the other dimension ("B-D axis") is the blend of oscillators B and D. The mixer values for each oscillator are represented as percentages and always add up to 100%. So, when the joystick is centered, each oscillator level is 25% of the overall mix. One oscillator can have 100% of the mix.

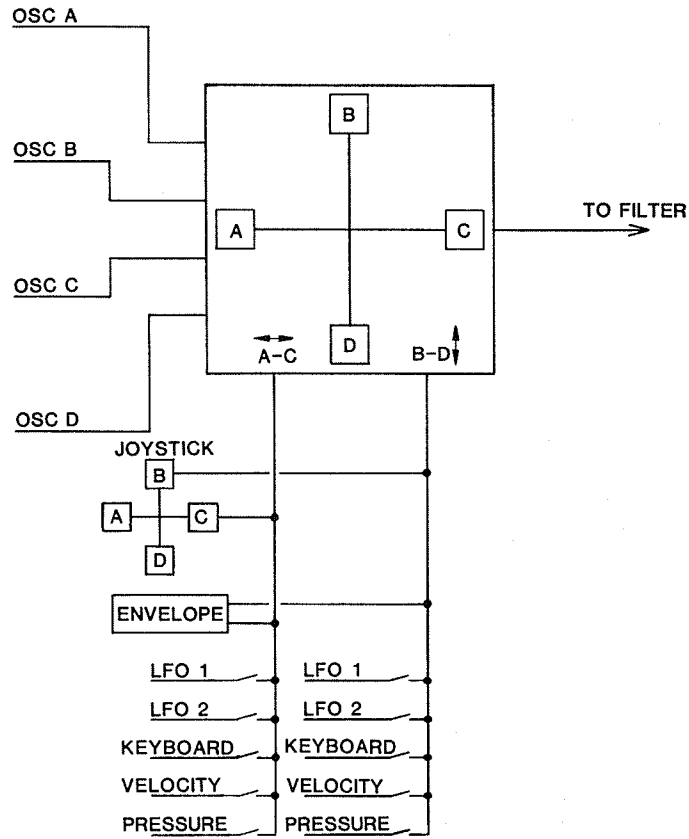

Figure 6-3
OSCILLATOR MIXER

Typical mix ratios are shown in Figure 6-4.

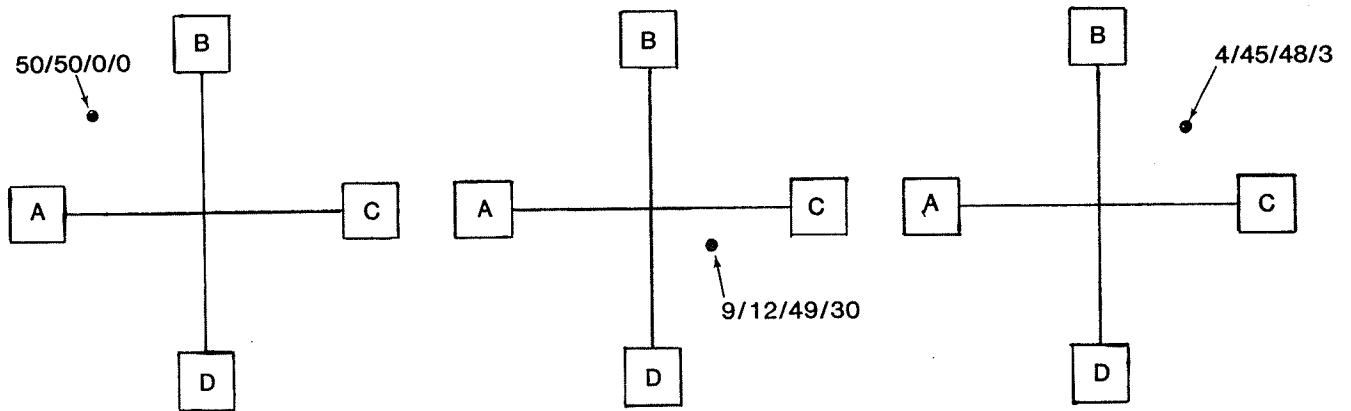

Figure 6-4
TYPICAL MIX RATIOS

In this mixer design, then, each mixture point represents a different timbre resulting from the unique combination of the four source waveshapes. New waveshapes can be created (edited) with the joystick in a similar fashion, then retained in RAM and assigned to any oscillator position (A - D), for remixing into yet more new timbres.

VECTOR SYNTHESIS

While it sounds very complex, the basic concept of vector synthesis is quite simple. It just means that while the note is playing, instead of staying in one place, the oscillator mixer point can be made to move throughout the mixture plane. The movement can be slow or fast, simple or complex, occasional or constant. In all cases, the output from the oscillator section will be one waveshape that changes timbre more or less quickly, as the point moves. This dynamic movement of the mixture point results in complex and lively timbre modulation unlike anything heard before. And since different waveforms often have different energies, variations in effective loudness are also created in addition to timbral changes.

In geometry, vectors represent quantities that not only have a value, but have a direction as well. In other words, a vector describes the movement of a point. The advantage of the coordinate system is that regardless of how complex the desired movement is, it can be described by simply changing the values of only two numbers, which of course represent the x and y axes. Depending on exactly how the x and y values change, the vector can move the point in simple straight lines or in elaborate geometric shapes or curves.

In addition to the physical movement with the joystick already mentioned, there are a variety of faster, electronic means available for moving (modulating) the mixer point. The mixture point can be moved independently along either axis by either LFO, by the key position, velocity, or keyboard pressure. The mixer point can also be moved along both axes simultaneously by the mixer envelope generator (discussed in Section 8).

Of course with several modulation sources applied to each axis, the vector movement of the mixture point becomes very complex and hard to imagine. Fortunately, because the effect of dynamic wave mixing is not predicatable, to produce interesting sounds it is not even necessary to think about the exact movement of the point. (That is for the computer to figure out!) It is only necessary to learn how to use the mixer modulation sources.

For example, those with some math or electronics background may be better able to intuitively picture the movements which will result from applying one LFO triangle wave to the A-C axis and the other to the B-D axis. Similar to Lissajous patterns, you can make the mixture point move in a diamond through all four quadrants, or trace figure-8s. But no one knows what this movement will sound like when

it is actually mixing specific waveforms. The connection between the mathematical picture of the mixer point in motion and the resulting sound is something which must be heard empirically with specific waves to be understood.

If this all sounds too far out, that's okay: sometimes we don't really believe it either. But the sounds produced speak for themselves. A model may help: Think of a quadraphonic sound system, with four speakers enclosing a square space. The joystick, of course, is similar to a quad balance control. Each speaker supplies a different timbre, such as a clarinet on one, harmonica on another, an organ and tuba on the remainder. Now suppose that in your hand is an omnidirectional microphone which picks up the sum of the timbres at any particular point within the field. When you stand in the center, the microphone picks up an equal mix of all four timbres. To understand vector synthesis, you have to try to imagine what the microphone picks up as you walk back and forth, or run really quickly around the room (like 20 times in a second!).

Since words can take us no farther in describing sound, the best way to learn vector synthesis will be not by studying vectors, but by getting right into the front panel, experimenting with different waveforms and mixer modulations, and listening carefully to the result.

OSCILLATOR GROUP CONTROLS

There is one basic display from which all oscillator parameters are edited. This display appears upon pressing any of the four **Oscillator Group** switches. The display format is as follows:

(oscillator A-D) (wave#)
Frequency: (coarse).(fine)

Control over these parameters is achieved through four switches. **Oscillator Select** selects the oscillator being adjusted, and **Wave#**, **Coarse Freq**, and **Fine Freq** select the parameter to be adjusted. Each control is discussed below.

In order to monitor oscillator parameter changes, it may be useful to isolate one of the oscillators from the other three. Several utilities are provided for this purpose, and are discussed under "The VS Basic Patch."

Select

This is the only oscillator control which is not adjusted with the slider. Instead, it either selects the oscillator control group, or advances the LCD to the next oscillator (A-D) and displays its three parameter settings.

1. Press **Oscillator Select**.

The display shows the selected oscillator (A-D), the wave number assigned to that oscillator (internal or cartridge 0-126, and noise), and its initial frequency (00.00 - 24.99).

The display cursor underlines one of the three oscillator parameters.

2. To adjust the current oscillator parameter, use the slider.
3. To select another parameter of the current oscillator, press either **Wave#**, **Coarse Freq**, or **Fine Freq**.
4. To select another oscillator, press **Oscillator Select** until the desired oscillator (A-D) appears in the top display line, then repeat the last two steps.

Stepping through the oscillators with **Oscillator Select** does not alter the position of the display cursor. This method of adjusting oscillator parameters allows you to quickly modify program settings either one oscillator at a time (by switching between parameters), or one parameter at a time (by switching between oscillators).

Descriptions of each oscillator parameter follow.

Wave

Each oscillator may generate a different waveform. When **Wave#** is selected, the slider adjusts the wave number assigned to the current oscillator. There are 127 waveforms available. Waveforms are organized as follows:

0 - 31	User waves (RAM)
32 - 127	ROM waves
	#32: Sine wave
	#126: Null wave (silence)
	#127: White noise

The musical value of specific waveforms can only be learned through trial and error, working with various program settings ("patches"). Although some simple waveforms are included, the ROM waveforms are much more complex than the typical sawtooth and pulse waves on an analog synthesizer, and therefore they do not lend themselves to generalizations such as "sounds brassy", or "contains only odd harmonics." Since they were created and are edited by ear, there is no point attempting to discuss the specific harmonic content of the ROM waveforms.

Coarse Freq and Fine Freq

Each oscillator's tuning is displayed as a four-digit number. The first two digits represent the coarse frequency (number of semitones

above concert pitch), which is adjusted by pressing **Coarse Freq**, then adjusting the slider. For basic "concert" tuning, set **Coarse Freq** to 0. For that oscillator, middle C will then be located at key C3. Values 12 and 24 are one and two octaves above, respectively.

The second two digits represent the oscillator detuning in cents (hundredths of semitone), which is adjusted by pressing **Fine Freq**, then adjusting the slider. **Fine Freq** is often left set to zero, so that the oscillator is not detuned. However, detuning is actually a great resource for making timbres sound less pure and machine-like.

Mixer Modulation

The A, B, C, and D mixer amounts always add up to 100, and the mixer can not be modulated beyond these limits. If you want to modulate the A-C or B-D mix ratios with velocity, pressure, key position, or either LFO, remember that positive modulation amounts increase the amount of oscillator C or D, and are more effective when the mixer is emphasizing oscillators A or B (respectively). Similarly, for negative modulation, the original mixer envelope should emphasize oscillators C or D. Since the LFOs have positive and negative phases, no single oscillator need be emphasized in the mixer envelope for LFO modulation.

THE BASIC VS PATCH

If you are editing programs for the first time, you may find that changing one oscillator's parameters has more or less effect than other oscillators in a given program. This may be due to the mix envelope which determines how the oscillator is heard. To eliminate some of the confusion which may arise, use the basic patch.

This basic patch is a good starting point for programmers. It opens the filter, creates an "on/off," organ-style envelope, disconnects all modulation, and creates a simple mix envelope. Initially, all four oscillators are set to the same waveform.

1. To select the basic program, hold down **Enter**, then press **0**.
2. Edit the basic patch, then if desired, store it.

Another useful programming tool is the basic mixer envelope, which gives an equal blend of all four oscillators through all points of the mixer envelope. (For more details, please refer to Section 8.)

SECTION 7

FILTER

This section describes the filter function and filter controls.

FILTER BASICS

While in the Prophet-VS emphasis is placed on its unique oscillator section, let's not forget about the filter. Skillful use of the filter module is also very important for making interesting sounds. Each voice contains a four-pole low-pass filter, with controlled cutoff and resonance and a dedicated envelope generator.

The filter is basically a brightness control: the lower its cutoff frequency is set, the duller the tone. Basically, the filter sets an upper limit to the frequencies which can pass to the amplifier. "Cutoff" is the frequency below which oscillator energy is allowed through. The higher the setting, the higher the frequencies are which pass through the filter. Thus, the brighter the sound.

To dynamically filter the voice timbre during the note, the filter envelope generator and other modulation sources are used. When triggered by the note being played, this envelope generator produces changes in the filter cutoff frequency which are analogous to the envelope produced. Several other modulators can affect filter cutoff or the filter envelope depth, such as velocity or either LFO. For example, velocity can control the depth of the filter envelope. Understanding the filter means knowing how to use all the cutoff control sources.

The filter envelope can also be used as a general modulation source. The envelope generator is discussed in Section 8.

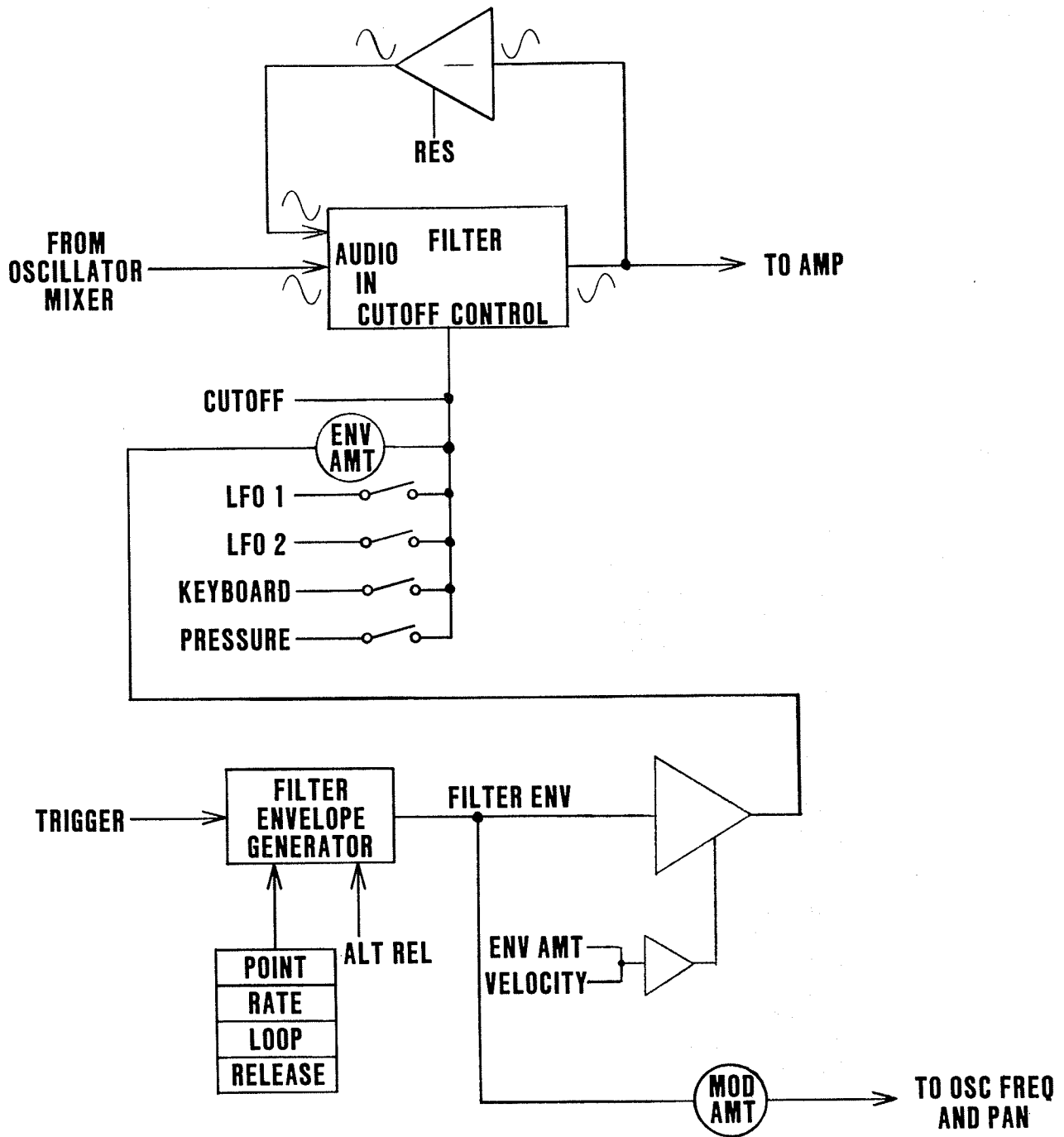

Figure 7-1
FILTER MODULE

CUTOFF

This parameter adjusts the initial cutoff frequency of the filter, over an eleven-octave range.

To adjust filter cutoff:

1. Press **Cutoff**.

The top line of the display shows the cutoff value from 0 - 99 and the resonance value. The bottom line displays the envelope amount value.

2. Adjust slider to desired value.

The scaling of this parameter is such that to raise or lower the cutoff by an octave, you would add or subtract about 9 units. To isolate the effect of **Cutoff**, set **Env Amount** to 0, and switch all filter modulation sources off:

- a. Under **MODULATION**, press **Dest Select** until the lower line reads "FILTER" or "FIL ENV".
- b. Set the filter destination off with the slider.
- c. To find other sources affecting the filter, press **Source Select** until the lower line reads "FILTER: ON" again.
- d. Press **Dest Select**, then turn off with the slider.
- e. Repeat the last two steps until no modulation sources are routed to the filter. (For more information on modulation, see Section 10.)

Cutoff is one of the most important synthesizer functions and has a critical effect on the timbre, but the **Cutoff** parameter is only one source of cutoff control. Note that since there are so many sources of filter cutoff control, it is possible to inadvertently disable the filter by raising **Cutoff** too high, or applying so much envelope or modulation that the cutoff frequency is pushed beyond the normal audio range, therefore ceasing to have any filtering effect. If nothing can be heard, also check that the cutoff is not set too low, or being driven too low by any modulation sources (see Section 10).

Note that if you want the filter cutoff to increase with key position--which will often be the case--this must be specifically patched through the modulation module. (In other words, route the keyboard source to the filter destination.) When the keyboard modulation amount is set near 50, the keyboard maintains the cutoff parallel to the oscillator frequency. With the filter thus "tracking" the keyboard, cutoff frequency is maintained at a constant point relative to the frequency of the note being played. Regardless of the position of the note, the relative harmonic energy is the same. This results in a consistent timbre throughout the program. You can demonstrate this

by using resonance to focus on a specific harmonic, while playing over the playback range. The harmonic interval will remain the same despite the key played.

When the keyboard modulation source amount is above 55, "overtracking" occurs. That is, higher notes are relatively brighter. Similarly, when the keyboard source amount is below 50, higher notes are relatively duller.

For any keyboard scaling, the filter cutoff pivots around the F#3 key. When the keyboard modulation source is set negative, the filter cutoff increases with lower notes, and decreases with higher notes.

For the broadest filter sweeps, when using a positive **Env Amount** value, lower **Cutoff**. When using a negative **Env Amount** value, increase **Cutoff**.

Since this is a four-pole low-pass filter, the higher-frequency components of the oscillator mixture (that is, all those above the cutoff frequency) are suppressed at a rate of 24 dB of attenuation per octave. In other words, the harmonic that is one octave above the cutoff frequency is attenuated 24 dB with respect to the cutoff frequency. (This is a sharper filter response than, say, 12 dB/octave.)

RESONANCE

Besides cutoff, the other filter adjustment which is critical to timbre is resonance.

To set filter resonance, press **Resonance** and use the slider (00-99). The filters begin to oscillate when the value is approximately 70.

Resonance is the only resonance control. When resonance is low, the filter has its standard response. As resonance increases, all filter effects are heightened or accentuated as the filter response curve becomes more complex. Frequencies below cutoff are suppressed while frequencies near cutoff are actually amplified. If the cutoff frequency is then modulated, this resonating filter sweeps across the harmonically-rich input, accentuating those harmonics near the (varying) cutoff frequency. This is a practical way to bring out a specific range of overtones or replicate certain physical resonances of acoustic instruments.

When resonance is set very high, the filter can be used as a sine-wave audio source. This will typically produce a howl or whistling. The exact resonance point may vary slightly from voice to voice. The pitch of this resonating oscillation is determined by the filter cutoff frequency (as modulated by all its controllers). The resonating waveshape is a sine wave because only one frequency (namely, cutoff) is present.

Filters operate in part by shifting the phase of their input signals. The amount of phase shift changes with frequency. To the extent that

resonance is raised, LFO-modulation of the cutoff frequency can impose an actual vibrato (frequency shift) on the audio path because of the resulting phase shift.

Another technique for applying filter phase properties is more appropriate for complex sounds. When filter resonance is high, the input signal will tend to synchronize the filter frequency to itself or to a harmonic. If then only the input signal to the resonating filter is shifted through modulation, the resonant filter will not change frequency, but will shift phase, producing a harmonic sweep. (If under these conditions the difference between input and filter frequency becomes very large, low-frequency beating may occur which may be useful or merely obnoxious.)

A slightly technical note on filter resonance. Refer to Figure 7-1. As the input signal frequency approaches cutoff frequency, phase shift of the filter output approaches 180 degrees (inversion). The resonance feedback amplifier is an inverter. Therefore these two inversions result in a net phase match at the cutoff frequency (which becomes the resonant frequency), due to the positive feedback. These frequencies are boosted, while frequencies farther below cutoff are attenuated due to the net negative feedback which they receive.

ENV AMOUNT

As shown on Figure 7-1, this parameter sets the amount of filter envelope which is allowed to modulate the cutoff.

To adjust envelope amount, press **Env Amount** and use the slider (00-99).

Env Amount has crucial control over the filter modulation of each program. It sets the maximum positive or negative depth of "contour" modulation applied by the envelope generator to the filter cutoff. It is very important for balancing the effect of the envelope against the **Cutoff** parameter. When **Env Amount** is set to 0, there is no envelope. In this case, cutoff control primarily results from the cutoff, keyboard modulation source amount, and velocity.

As the envelope amount is adjusted towards either extreme, the timbre of the note depends increasingly on the filter envelope, most notably at low cutoff settings. When **Env Amount** is set positively, the cutoff frequency never goes below the **Cutoff** level. When set negatively, the cutoff frequency never goes above the **Cutoff** level. To generate more noticeable frequency sweeps when **Env Amount** is increased toward +99, **Cutoff** is usually decreased.

(To more clearly hear the effect of a filter sweep, temporarily increase the resonance to the point where you can more distinctly hear the changes in the resonant pitch.)

SECTION 8

ENVELOPE GROUP

This section covers adjustment of the mixer, filter, and amplifier envelope generators.

ENVELOPE GENERATORS

Sounds have beginnings, middles, and ends, and what occurs during each stage may vary widely. For example, the end of an organ sound is as loud as the beginning, but a piano note or snare drum begins at a certain level then quickly falls to zero. It is important to remember that when describing the shape of sound in this way, we are most often talking about its amplitude envelope--how its loudness changes over time.

The envelope generators give synthetic sounds their identities of transient beginnings, sustained timbre and volume, and final release characteristics. They do this by changing one or two values over time. The rate of change is much slower than an audio wave, so that the envelope is considered an event, and the voltage, dc.

The envelopes mingle intimately with your keyboard technique. The speed at which notes are played has a great deal to do with the appropriateness of certain envelope settings. Programs with short envelope timings invite faster playing than those with longer timings.

Each voice has three independent envelope generators: for the oscillator mixer, filter cutoff, and amplifier level. The oscillator mixer envelope application forms the basis of "Vector Synthesis." The filter and amplifier envelope applications are a little more traditional, but completely new sounds are possible due to the way in which the envelope shape can be drawn. These envelopes go far beyond the traditional ADSR scheme: they have five stages, plus looping functions. This makes them capable of a variety of effects, such as multiple attacks, echo, etc.

The essential points to be aware of for performance are that the envelope generators are "triggered" into action only when you press a key, the velocity with which you play can be used to actually change

key, the velocity with which you play can be used to actually change the effective depth of the filter and amplifier envelopes as well as determine the peak level of either envelope, and the **Alternate Release** footswitch is used to modify the release settings.

MIXER ENVELOPE

Referring for a moment to Figure 6-3, the most important mixer controller is the mixer envelope. It serves the very interesting role of in effect moving the joystick for you, very quickly. In fact, to program the mixer envelope, you just move the joystick to the desired mix positions, and set the rate at which the point will move between them. The main difference between the mixer envelope and the other mixer modulation sources is that the other sources are one-dimensional; they change one value at a time. The mixer envelope, however, is two-dimensional: it supplies separate x and y coordinates so that vectors can be drawn through the mixer plane, as shown in Figure 8-1.

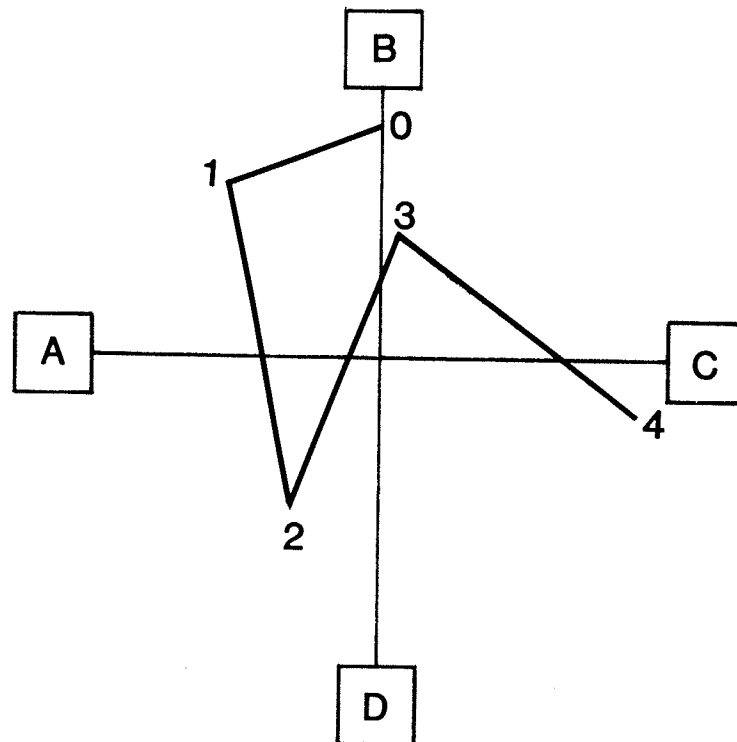

Figure 8-1
MIXER ENVELOPE

When the key is pressed, the mixture moves from point 0 to point 1 at a certain rate, called rate 1. Then it moves from points 1 to 2 at rate 2, and from points 2 to 3 at rate 3. These three vectors can be used to define the attack timbre of the note. They are linear, in other words, within each segment the rate of motion is constant.

While the key is held, the mixture point may remain at point 3. Or, by looping the mixer envelope, you can continuously sweep through up to three different vectors in the plane. In other words, the mixer point can oscillate between point 3 through any previous segments.

Normally, when the key is released, the mix point moves from 3 to 4 at rate 4, unless the alternate release footswitch is held, in which case it moves from point 3 to point 4 at rate 4A. In either case, to retain a desired feature of traditional instruments, this final release vector is not linear, but exponential. This just means that the point moves quickly at first, then gradually slows down.

Effects of Mix Joystick

The x and y coordinates of the mixer envelope can be modulated by several sources, such as velocity or either LFO, creating subtle timbral changes as the oscillator blend changes. If you want to accent specific notes with further timbral shifts, the Mix joystick can also temporarily modify the oscillator blend without overriding the mixer envelope, making it a unique performance controller.

Unlike the Pitch wheel (which affects the pitch of all oscillators based on its current position), the joystick affects the blend of each note based on how far, and in which direction it is moved during each note. That is, if the joystick is moved all the way from A to C while a note is held, the amount of oscillator C increases for that note. If the joystick then remains stationary, and another key is played, it plays with an unmodified mixer envelope. All joystick movement relative to its initial position when a note is played determines the shift in x and y coordinates.

Figure 8-2 demonstrates the effect of moving the joystick b) from its initial position to C between mixer envelope points 1 and 2; and c) from C to B between envelope points 2 and 3.

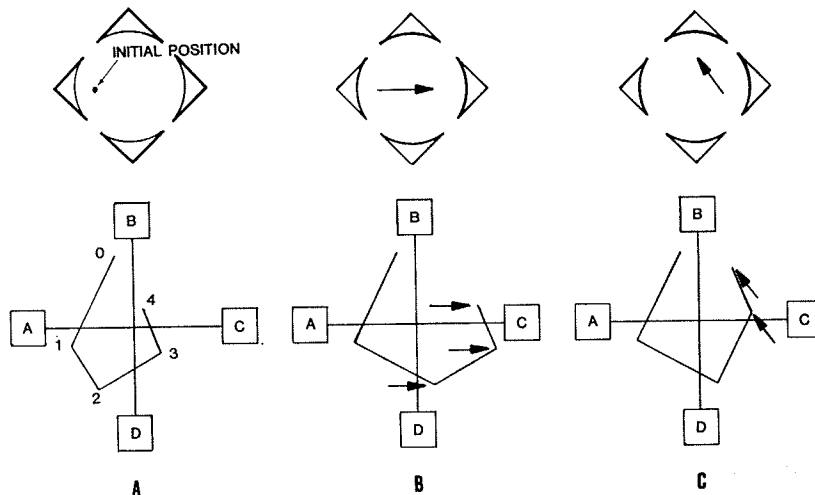

Figure 8-2
EFFECTS OF MIX JOYSTICK

Obviously, if the joystick is initial positioned for 100% of oscillator C (far right) initially, then the joystick can only increase the mix amounts of oscillators A, B, and D.

Another performance application for the joystick is editing one point of the mixer envelope as you play. Simply select one of the four mixer envelope points, then move the joystick. Instead of changing the entire envelope per note, the joystick position determines the oscillator blend at that point of the mixer envelope. All other points and rates are unaffected:

1. Select the desired program.
2. Press **Envelope Select** until the display reads "MIX ENVELOPE".
3. Press point until the desired point is displayed. (Remember that the first point is point "0.")
4. As you play the keyboard, adjust the joystick.
5. If desired, select other point numbers, and continue.
6. If desired, you can store the edited program. (See Section 3.)
7. To return the original program, enter the original two digits.

FILTER ENVELOPE

While the mixer envelope is a position control, the filter and amplifier envelopes are level or amount controls. They function similarly to the mixer envelope, except only in one dimension. The filter envelope generator is diagrammed with the filter, Figure 7-1. The overall filter envelope depth is controlled by the envelope amount control.

Referring to Figure 8-3, the normal sequence of the filter (or amplifier) envelope is as follows:

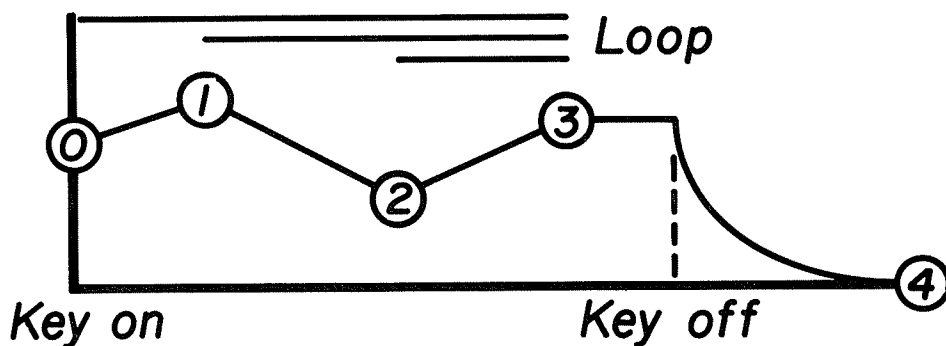

Figure 8-3
FILTER/AMPLIFIER ENVELOPE

When key is pressed, envelope begins at level 0, proceeds to point 1 at rate 1, proceeds to point 2 at rate 2, to point 3 at rate 3. These are all linear (same-rate) movements. Provided the key is still held, the envelope will remain at level 3. The envelope may loop from or between point 3 and any previous point. Whenever the key is released, the envelope falls to zero at rate 4. (In the case of the amplifier envelope, level 4 is always 0.) If the **ALTERNATE RELEASE** footswitch is held when the release occurs, rate 4A is used instead. In either case, the release follows an exponential curve to level 4.

Figure 8-4 shows some simple envelopes which would be impossible to do with the standard ADSRs. In (a) there is an initial delay, in (b) the attack goes negative then positive (inverted envelope), and (c) gives a double attack.

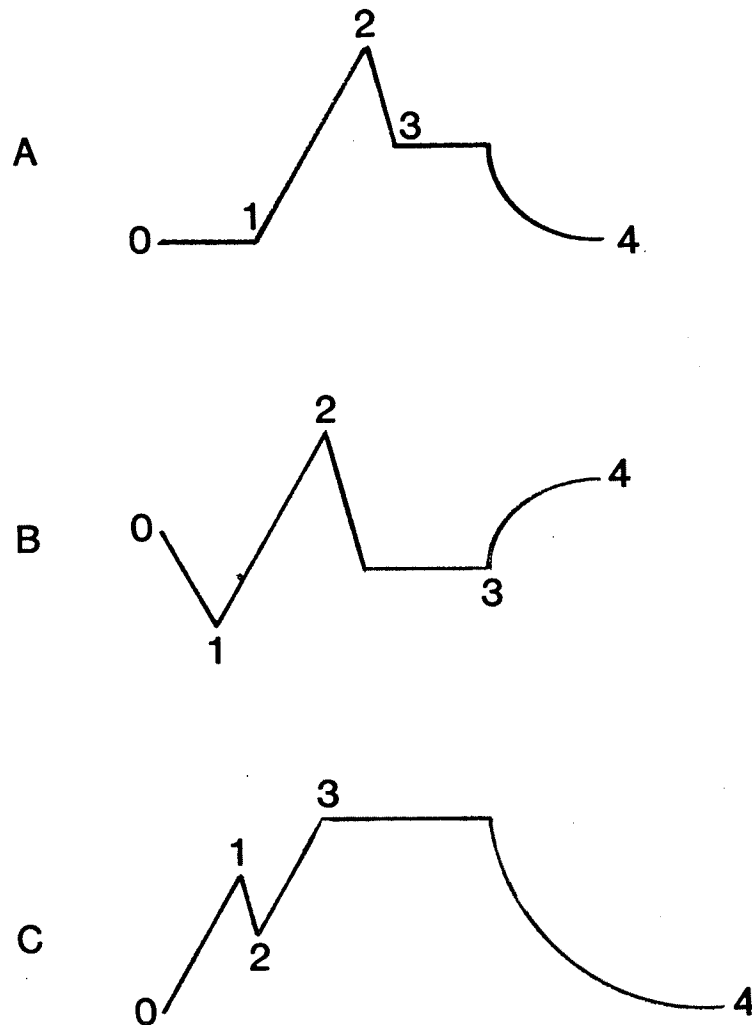

Figure 8-4
ENVELOPE EXAMPLES

Figure 8-5 shows the results of looping envelopes. If the loop is off, then the envelope remains at point 3 with level 3 for as long as the key is held. But by using envelope looping, LFO, restrike, and echo effects can be created. In (a) the loop is between points 2 and 3, in forward/backward mode, with two repeats. This produces a short tremolo (if applied to the amplifier). In (b) the 1-2-3 segment is repeated a few times, which in effect creates an interesting waveform out of the envelope. In (c), the oscillation effect is more obvious.

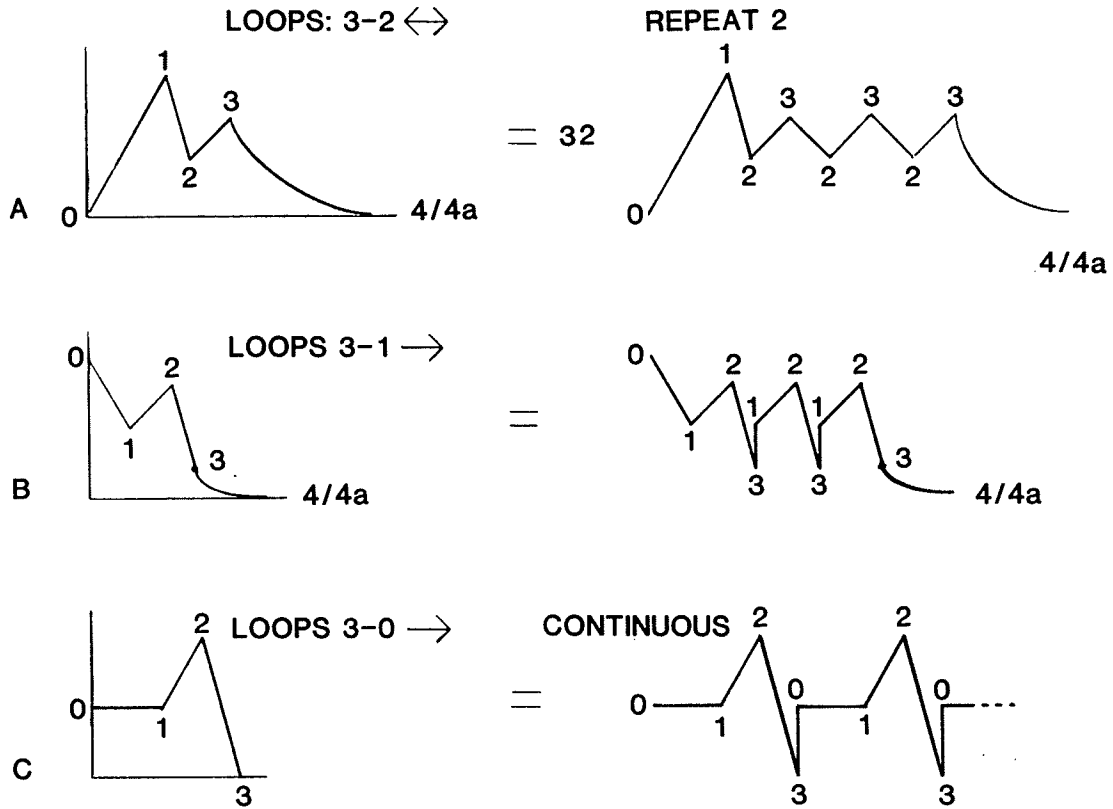

Figure 8-5
ENVELOPE LOOP EXAMPLES

For an exponential attack, you have to approximate the shape using linear segments. In other words, segment 0-1 would have a slight slope; segment 1-2 a medium or higher slope; and if desired, segment 2-3 a steep slope.

AMPLIFIER

The filter audio output goes to the voice amplifier. The amplifier determines the loudness of the voice over the note duration. Its output goes to the pan module.

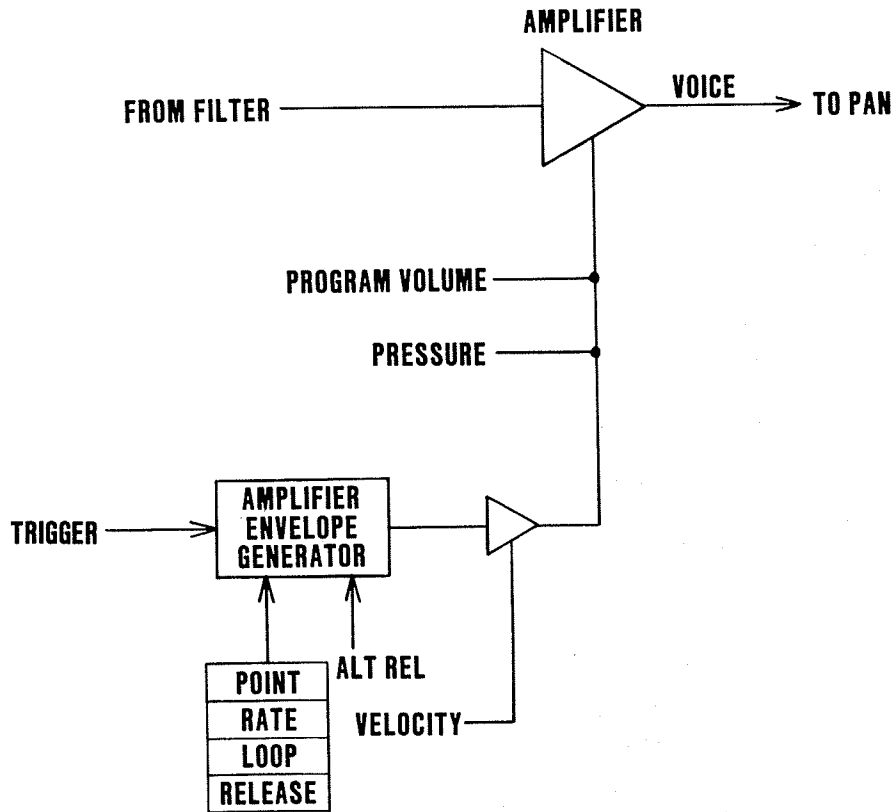

Figure 8-6
AMPLIFIER MODULE

Each program has a programmed volume which is affected by other parameters: principally, the amplifier envelope generator, which articulates the desired loudness shape, and the modulation sources. Through the modulation system, the volume can be raised or lowered by key velocity or pressure. These sources are added to the program volume. That is, positive modulation amounts drive the volume higher, and negative amounts drive it lower.

Note that there is a maximum program volume of 99, and modulation can drive the volume no higher. To hear the effects of the amplifier envelope generator, velocity, or pressure on program volume, lower **Program Volume**, and raise the modulation source amount.

If two programs are mixed in Double keyboard mode, all of these volume control sources will affect the balance between the two sounds.

ENVELOPE SELECT

To select the mixer, filter, or amplifier envelope for adjustment, press **Envelope Select**.

The name of the selected envelope and point appear in the top line of the display.

In the lower line of the display appears the rate for the selected point, or the loop and repeat selections, depending on which parameter has been selected.

BASIC MIXER ENVELOPE

Before editing the mixer envelope, you may want to hear what all four oscillators sound like when mixed equally, without the influence of the mixer envelope. The VS provides a basic mixer envelope which can be selected without affecting the rest of the program.

To select the basic mixer envelope:

1. Select the desired program.
2. Hold down **Enter** and press 1.

Playing the keyboard reveals that the mixer envelope provides an equal mix of all four oscillators through all four points. The mixer envelope rates are unaffected.

3. If desired, edit the mixer envelope rates and levels as described below.

POINT

1. If necessary, select the desired envelope with **Envelope Select**.
2. To select envelope point, press **Point Select**.

This increments the point number from 0 through 4. The LCD shows the current envelope and envelope parameter.

3. To select point 4A, hold down the **ALTERNATE RELEASE** footswitch.

The LCD will tell you that "ALTERNATE RELEASE" is selected.

RATE

1. Press **Rate**.

The LCD shows the current envelope, point, and rate.

2. If necessary, select the desired envelope and point number with the corresponding switches (see above).
3. To select rate 4A, press the **ALTERNATE RELEASE** footswitch.
4. Adjust the slider from 0 - 99.
5. Play the keyboard to test the effect of the new rate.

LEVEL

1. Press **Level**.

The LCD shows the current envelope, point, and level.

If the mix envelope is selected, the level is displayed as the four oscillator mixture percentages.

2. If necessary, select the desired envelope and point number with the corresponding switches (see above).
3. Adjust the slider from 0 - 99, or if the mix envelope is selected, use the joystick to set the mixture for the current envelope point.

For the amplifier envelope, levels 4 and 4A are pre-defined as 0.

4. Play the keyboard to test the effect of the new level.

LOOP

Envelope loops were described above.

1. Press **Loop**.
2. Select desired envelope.
3. Use slider to select loop mode:

<u>Display</u>	
OFF	Off
0 →	Forward from 0
1 →	Forward from 1
2 →	Forward from 2
0 ↔	Backward/Forward to 0
1 ↔	Backward/Forward to 1
2 ↔	Backard/Forward to 2

REPEAT

1. Press **Repeat**.
2. Select desired envelope.
3. Use slider to select number of loop repetitions, from 1-6, or "C" (continuous).

SECTION 9
LFO GROUP

This section explains the LFO functions and controls.

LFO BASICS

There are two independent, variable-rate LFOs with selectable waveshapes. The LFO output levels are adjusted by the combination of initial modulation level (set via the Modulation module), the Mod wheel, pressure, and the other LFO.

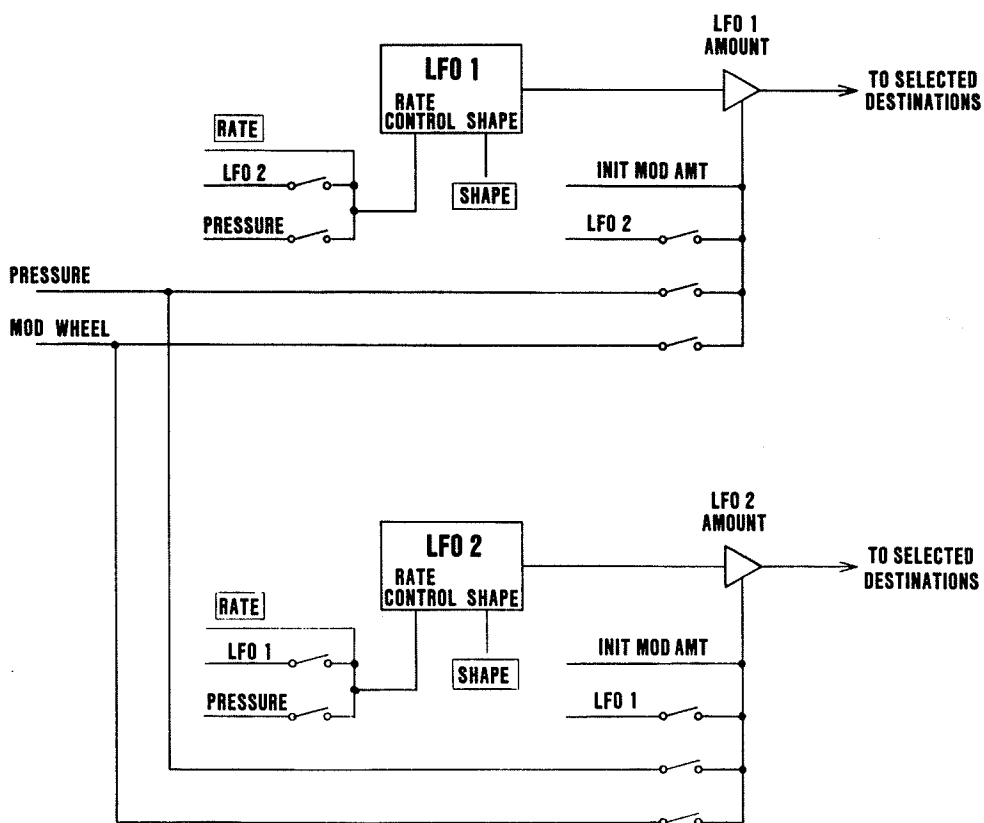

Figure 9-1
LFO MODULE

The modulation (Mod) wheel is closely related to the LFOs because they are the source of the modulation that the Mod wheel applies. By moving the Mod wheel up and down, you vary the level of the modulation signal from the LFOs to the selected modulation destinations. The Mod wheel is totally monophonic. In other words, it affects all voices, regardless of the keyboard mode.

The LFOs can be switched to modulate most of the destinations in the modulation system. (For more information, see Section 10.)

LFO SELECT

LFO Select toggles between LFOs 1 and 2. The LCD displays the selected shape and rate.

SHAPE

1. Select LFO 1 or 2.
2. Press **Shape**.
3. Use slider to select desired shape:

TRIANGLE
SQUARE
SAWTOOTH (descending)
RAMP (ascending)
RANDOM

RATE

1. Select LFO 1 or 2.
2. Press **Rate**.
3. Use the slider to set the desired rate, from 0 - 99.

SECTION 10

MODULATION

This section explains use of the modulation control module.

MODULATION BASICS

The timbral and processing power of the modules in the audio path define the basic sound of a synthesizer. But the synthesizer's expressiveness depends entirely on its modulation resources. Modulation allows the performer to apply a combination of physical or electrical techniques to animate the sound; that is, turn it from a static, fixed timbre into a responsive and dynamic musical event.

The Prophet-VS has an extensive modulation system. On the front panel is a graph which shows which modulation sources can be routed to which destinations. In this manual, the various modulation sources have been illustrated in the block diagrams and discussed in the "BASICS" paragraphs that introduce each module. (For example, the diagram of the oscillator mixer in Section 8 shows the possible mixer modulation sources.)

Physical sources of modulation include the keyboard (key position), velocity, pressure, the wheels, and the joystick. In addition to the three envelope generators, electrical sources of modulation include the two LFOs. These can be used to sweep oscillator pitch, oscillator mixture, filter cutoff, LFO rate or depth, voice pan, and chorus rate or depth.

SOURCE SELECT and DESTINATION SELECT

In general, to set up modulation paths:

1. Press **Source Select** for desired source.

The LCD shows the current source selection in the top line, and the amount to which it has been set.

- To adjust the source amount, use the slider.

The Mod wheel choices are "OFF" and "ON" - because it is an amount adjustment.

LFO 1 and LFO 2 source amounts range from 00-99. All other sources are bipolar (-99 - 0 - +99)

- To select destinations, press **Dest Select**.

In the lower line is the name of the current destination selection, and its status: off or on.

Only the allowed paths for the selected source can be selected:

Source	Freq	Filter	Mix	LFO 1	LFO 2	Amp	Pan	Chorus
LFO 1	A, B, C, or D	Filter	A-C, B-D		Amount, Rate		Pan	
LFO 2	A, B, C, or D	Filter	A-C, B-D	Amount, Rate			Pan	
Pressure	A, B, C, or D	Filter	A-C, B-D	Amount, Rate	Amount, Rate	Volume	Pan	Rate, Depth
Velocity		Env Depth	A-C, B-D			Env Depth	Pan	
Keyboard		Filter	A-C, B-D				Pan	
Filter Env	All 4 Osc						Pan	
Mod Wheel				Amount	Amount			Depth

Figure 10-1
MODULATION SOURCES AND DESTINATIONS

- To toggle the destination on and off, adjust the slider.
- Repeat for other sources.

Destinations receive the total modulation of all applied sources.

To start from a specific destination, and change the applicable modulation sources:

- Select the desired modulation destination with **Dest Select**.

2. Press **Source Select**, then adjust the modulation amount.
3. Cycle through the other sources with **Source Select**.

The lower LCD line remains at the selected destination, unless the selected source cannot modulate it, in which case the next destination is temporarily selected.

SECTION 11

VOICE CONTROLS

UNISON/DETUNE

When Unison mode is on, all voices (eight if normal, four if Split or Double mode) play only the lowest key played. This makes a "fat" sound which can be even further enlarged through the detuning option. Unison creates thick sounds because the voices do not actually play simultaneously. There is always a certain minimum delay that causes the voices to be slightly out of phase.

In Unison mode, you can't play a chord. But Unison makes fast riffs easier to play, since only one note can be heard at a time.

1. To select Unison mode, press **Unison**.

UNISON OFF (or ON)
DETUNE AMT X (only if ON)

2. To switch Unison mode on/off, or adjust the detuning range, use the slider.

Unison mode is off when the slider is all the way down.

Detuning can only be adjusted when **Unison/Detune** is on.

Detune range is 1-7 cents.

This detuning is for this program in Unison mode. In Double mode the entire program can be detuned further.

GLIDE

Glide determines how long it takes to slide between notes. When 0, there is no glide effect and the oscillators step instantly between keyboard semitones. As **Glide** is increased, it takes longer for the

oscillator pitch to change. This introduces "portamento" between the notes, which can be subtle or quite extreme.

To adjust **Glide**:

1. Press **Glide**.
2. Use the slider.

The Glide range is 0-99. Notes glide at a linear, constant rate. The higher the Glide value, the longer it takes to glide from note to note.

VOICE PAN

The voice output can be positioned anywhere within the stereo field by the **Voice Pan** control and the modulation sources shown:

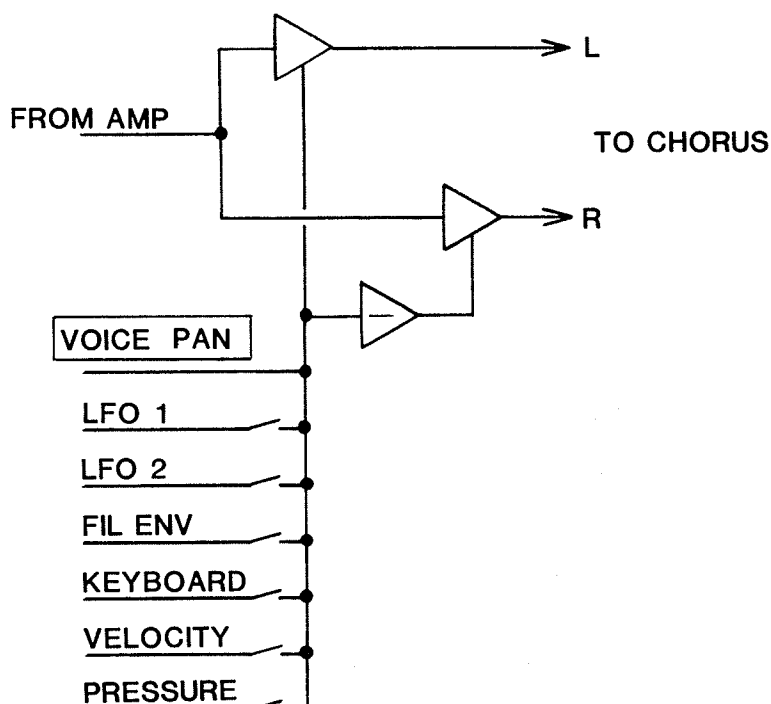

Figure 11-1
PAN MODULE

There are several new implications to this arrangement. For example, when modulated by the keyboard (key position), the placement of the note within the stereo field can be analogous to its position on the keyboard. This has been a long-desired feature for electronic keyboard instruments.

1. To select desired voice numbers, press **Voice Pan**.

The LCD shows the voice number and pan value from -63 to +63 on the top line. In the bottom line it provides a bar graph showing the approximate initial voice position. The resolution of the slider far exceeds that of the display. There are 42 display positions but 128 pan positions.

2. To adjust the voice pan, use the slider.

Panning Modulation

If you want a piano-type arrangement, you must pan all the voices to the center, then apply keyboard modulation to the pan destination.

For Split or Double modes, if you want a hard left/right output, you must pan voices 1-4 to one side and 5-8 to the other. In Split mode, voices 1-4 play the left (linked) program and voices 5-8 play the right (current) program.

Positive modulation moves a voice towards the right audio channel. Negative modulation, towards the left. LFOs are bipolar, so their effect is both positive and negative. Be sure to leave some panning margin if you want motion in both directions.

If too much modulation is applied to panning, the voice will pan as far as possible, until the combined modulation sources subside.

PROGRAM VOLUME

This control is used to reduce undesired apparent volume changes between programs. For best signal-to-noise ratio, it should be set as high as possible.

Program Volume sets the minimum volume for the program, to which selected modulation sources are added. For typical velocity control over volume, reduce **Program Volume** and increase the amount of velocity modulation. (See Section 10.)

1. Press **Program Volume**.
2. Adjust the displayed value with the slider.
3. Set up the desired sources to modulate volume. (See Section 10.)
4. Adjust the modulation amounts and **Program Volume** for the desired balance.

Note: If **Program Volume** is set too high, velocity (and other modulation sources) can only lower the volume with negative amounts of modulation, which may not be desired.

SECTION 12

CHORUS

CHORUS BASICS

The chorus adds thickness and warmth to the sound. There are two separate chorus circuits, which operate independently on the left or right output channel.

The chorus parameters are programmable per program. When the keyboard is in Single mode, the current rate and depth settings affect both choruses. In Split or Double mode, the left and right programs assign independent values to each chorus, producing two distinct chorus effects simultaneously. (See Section 4.)

Note: Voices are still panned to the audio channels as usual, so if voices played with the right program are to go through the right chorus only, you must make sure that all voices in the right program are panned to the right output (+99). Of course the same considerations apply to the left program voice assignment. (See Section 11.)

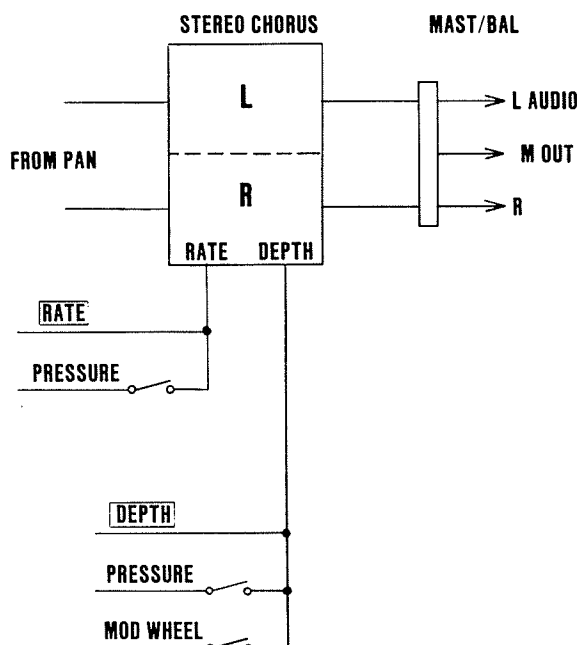

Figure 12-1
CHORUS MODULE

As shown in Figure 12-1, the Mod wheel can control the chorus depth, while the chorus rate or depth can be modulated by the pressure signal.

CHORUS LEFT

This switch toggles the left chorus on and off. An LED indicates current state. The LCD shows the settings of the initial Rate and Depth parameters.

CHORUS RIGHT

Toggles the right chorus on and off.

RATE/DEPTH

This switch moves the cursor between the Rate and Depth parameters. Use the slider to adjust value from 0 - 99.

SECTION 13

CREATING USER WAVEFORMS

This section explains how to create and store user waveforms. Familiarity with the VS's operation in Program Edit mode is assumed.

INTRODUCTION

There are two levels of sound editing on the Prophet VS. The first -- Program Edit mode-- deals with mixing, filtering and modulating the oscillators and other performance controls. In this mode, the joystick and other mixer controllers adjust the real-time mixture of the four oscillators. For performance, any group of parameter settings is easily recalled simply by selecting a program.

At the second level --Edit Waveform mode-- the only program elements altered are the waveshapes available to the oscillators. When the VS enters Edit Waveform mode, the current program is put aside temporarily, and a new set of editing rules apply. In this mode, the joystick adjusts the static mix of up to four waveforms, to produce a new waveform. When the VS exits Edit Waveform mode, the current program returns.

The process of creating user waveforms is typically as follows:

1. Enter Edit Waveform mode.
2. Select the desired four waveforms.
3. Set each oscillator to a harmonic pitch.
4. Adjust the waveform blend with the joystick.
5. Store the new waveform in RAM.

Note: Editing a waveform changes the sound of all programs that use that waveform. You must remember that storing a new wave destroys an old wave, and therefore changes any programs that use the number of that old wave.

So, before storing a wave it is a good idea to make sure that the NVRAM or RAM cartridge destination number you have in mind isn't crucial for your favorite program. Please see the paragraph below on the Review utility.

EDIT WAVEFORM MODE

When the **Edit Waveform** switch is off, the Prophet-VS operates normally, that is, in Program Edit mode. Of course switching **Edit Waveform** on activates Edit Waveform mode. The display reads:

```
WAVE MIX %  
Axx Bxx Cxx Dxx
```

When the VS enters Edit Waveform mode, it no longer plays the program selected in Program Edit mode. Instead, it plays a separate Edit Waveform program. There is only one such program, and it resides in the VS's non-volatile memory. (That is, it is not erased when the VS exits Edit Waveform mode or when power is switched off.) Its purpose is to provide a set of simple program parameters which will not conflict while you are editing waveforms. The mixer envelope is not used. Instead, the joystick position sets the blend of the four oscillator waveforms. With the exception of the **OSCILLATOR GROUP** and **Unison** controls, all program parameters operate, and may be adjusted as in Program Edit mode. If you wish, you can add modulation, resonance, or even looping envelopes to the Edit Waveform program, but since it is not intended for performance, there may be little point in doing so.

For simplicity, a basic, organ-style program is quickly available which essentially resets the Edit Waveform program. To select the basic Edit Waveform program:

1. Switch **Edit Waveform** off.
2. Hold down **Enter** and press **Edit Waveform**.

This enters Edit Waveform mode with the basic Edit Waveform program. All modulation is disabled, simple envelopes are employed, and all four oscillators are set to the same waveform (#32 sine wave). Changing the blend with the joystick appears to have no effect on the sound.

3. If desired, edit this basic program.

Editing Waveforms

1. Switch **Edit Waveform** on.

The LCD shows the mix percentages for the joystick position:

```
WAVE MIX %  
Axx Bxx Cxx Dxx
```

2. Select wave A, B, C, or D with **Oscillator Select**.
3. Press **Wave#**.

4. If necessary, select the desired wave numbers for each oscillator with the slider.
5. If desired, adjust each waveform's "harmonic" settings (see below).
6. To edit the current mixture, use **Waveform Mix** joystick.

You hear a live dry mix of the waveforms.

7. If desired, store the new waveform (see below).

Wave# and Harmonic

In addition to adjusting the mix between the four waveforms, it is possible to change the waves assigned to each oscillator, and the "harmonic" of each waveform to be mixed.

As explained in Section 6, in Program Edit mode, each oscillator has independent frequency control, allowing detuning in semitones or cents. When several oscillators are combined, then, each note played can produce rich textures (from the beating between slightly detuned oscillators), or even full chords. These effects are unique to programs.

When waveforms are combined in Edit Waveform mode, the fine and coarse frequency controls do not apply. Thus, the semitone/cent intervals cannot be produced by one waveform alone. Instead, the waveform frequencies can only be multiplied by integer amounts from 1-32. You may recognize some similarities between this method of editing waveforms and additive synthesis.

For example, suppose you want to blend four sine waves of different frequencies:

1. Enter Edit Waveform mode.
2. Press **Oscillator Select**.
3. Press **Wave#**.
4. Select wave #32 (sine wave) with the slider.
5. Select the other oscillators with **Oscillator Select** and set them all to wave #32 with the slider.
6. To select the harmonic function, press **Coarse Freq** or **Fine Freq**.
7. Adjust the current waveform harmonic with the slider. (Range is 1-32.)

The wave frequency is multiplied by the selected value. For example to generate the third harmonic, adjust the slider to "3."

8. Select other oscillators with **Oscillator Select**, then adjust the harmonic settings as desired.
9. Adjust the waveform blend with the joystick.
10. If desired, store the waveform.

STORING WAVEFORMS

When you are through editing a waveform, you can either store it, or exit Edit Waveform mode. If you choose to exit, the edited waveform will still be in Edit Waveform mode when you return, but it can not be used in any programs unless it is stored first.

Review

The purpose of this utility is to keep you from inadvertently destroying desired waveforms.

The Review utility assists you in finding a destination for your edited waveform, and shows you which waveforms are not needed by reporting how many internal or cartridge programs use a user waveform, and if desired, listing them by number and name.

Review also allows you to compare the current edited waveform with other waveforms in memory, and to audition the sound of a program when the edited wave is substituted into it.

1. Switch **Edit Waveform** on.
2. To review the current waveform selection, switch **Review** on.

This "freezes" the mixture set by the current joystick position, and holds it in a temporary RAM location.

3. Set slider to number of wave number to be reviewed.

The display reads:

```
n PROGRAMS USE  
INTERN WAVE #x
```

4. If desired, to review cartridge RAM cartridge waveforms, switch **Cartridge** on.
5. To compare the edited and current waveforms, toggle **Review** off and on.
6. To display the names and numbers of programs which use the waveform being reviewed, switch **Review** and **Store** on.

The display reads:

Int. Waveform #x
Prog #z (name)

The slider scrolls through the programs which use the reviewed waveform.

Store

To store the new waveform switch **Edit Waveform** on and:

1. To choose a suitable location for the new waveform, use **Review** (as explained above).
2. If desired, insert RAM cartridge and switch **Cartridge** on.
3. **Review** must be off.
4. Switch **Store** on.

This "freezes" the mixture set by the current joystick position, and prepares the machine to store the waveform into RAM (internal or cartridge).

If **Cartridge** is off, the display reads:

STORE WAVE IN
INT 32 (ENTER)

If **Cartridge** is on and a ROM cartridge is in place, it will ask you to insert a RAM cartridge.

When the RAM cartridge is selected and in place it will say:

STORE WAVEFORM
IN RAM CART xx

5. Select desired destination number (1-31) using the slider.
6. To exit, switch **Store** off.
7. To store the wave, press **Enter**.

This writes over the destination. The LCD displays the waveform mix ratios.

The new wave will now play in any program that uses it.

Note that this new user waveform can be used as a component of other new waveforms.

To create waves, throw away theory and listen a lot.

SECTION 14

MIDI

OVERVIEW

It probably goes without saying that the Musical Instrument Digital Interface has found its way onto practically every keyboard synthesizer currently available. The Prophet VS MIDI implementation is extensive and practical. No attempt is made in this manual to explain the workings of MIDI. Instead, specific applications for the VS in a MIDI system are outlined.

Each of the VS's MIDI parameters are common to all programs, and are remembered when power is switched off (with the exception of the MIDI PARAMETERS option, which is disabled at power-on).

BASIC CONNECTIONS

The most basic level of MIDI consists of sending notes from one instrument to another. In this case, the instrument being played is called the "master," and the instrument which plays along, the "slave." Figure 14-1 shows how the VS can be connected as the "master" in a MIDI system, with two slaves. Providing there are MIDI THRU jacks on each instrument, any number of instruments can be slaved from one master.

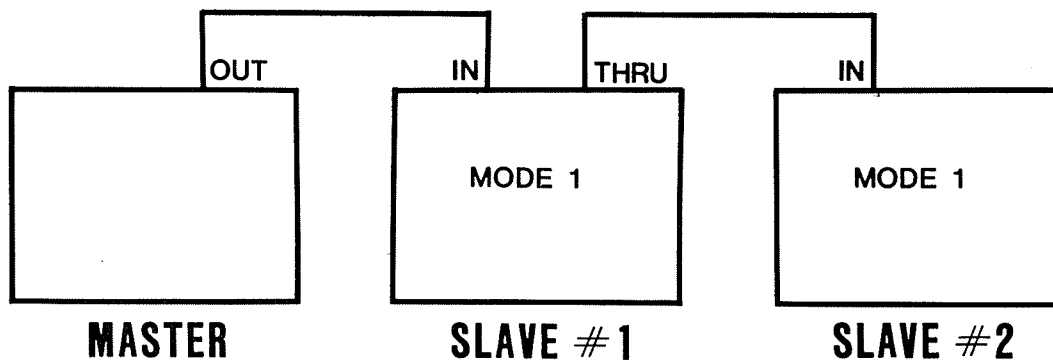

Figure 14-1
BASIC MIDI CONNECTIONS

Any notes played on the master will also be played on the slaves. Playing the slaves, on the other hand, has no effect on any other instrument in the "chain," unless their MIDI OUT is connected to another instrument's MIDI IN. In Figure 14-1, the first slave's MIDI OUT can drive the master's MIDI IN. This enables either keyboard to play the other. The first slave is unable to play the second slave though, because it does not transmit MIDI data over its MIDI THRU.

It is not a good idea to connect a slave's MIDI THRU to the master's MIDI IN, because doing so will cause all notes played on the master to reappear at its own MIDI IN, and if an arpeggiator or sequencer is running, this can add confusion.

Generally, whatever appears at an instrument's MIDI IN jack appears at its MIDI THRU, but not at its MIDI OUT.

Besides key information, there are other MIDI messages which can be sent from instrument to instrument such as the following:

Program Selections

Selecting a program on the master sends a "program change" message to any slaves in the MIDI chain, which then change programs. Program selections must be enabled on master and slave(s). (See MIDI OPTIONS, later in this section.) Since instruments may organize their programs in banks of ten (like the VS), eight (Prophet-5), or even twelve (Prophet-2000), the slave may not display the same program number as the master. In any case, for each program selected on the master, there is a corresponding program on the slave.

Wheels

Using the mod or pitch wheels on the master causes similar "wheel movement" on the slaves. Many synthesizers have different wheel ranges, so it may be necessary to adjust **Pitch Wheel Range** on the VS to match other instruments' ranges. Mod and pitch wheels must be enabled on master and slave(s). (See MIDI OPTIONS.)

MIDI Clock

Instruments featuring arpeggiators (like the VS), sequencers, and the like, usually transmit or recognize "MIDI Clock" messages as non-MIDI equipment would send or receive traditional clock or trigger signals. This allows several MIDI sequencers, arpeggiators, or drum machines to play in sync. MIDI clocks are encoded messages, however, and can only drive MIDI equipment. Many other timing messages are transmitted and recognized by the VS, and are explained under "SPECIFICATION," later in this section.

MIDI CHANNEL

The VS can transmit three channels simultaneously if necessary. These channels are:

RIGHT CHANNEL

This is the VS equivalent of the base channel. If the keyboard is not split, all notes are sent on the right channel, regardless of the mode. When the keyboard is split, only notes to the right of the split are sent on this channel. The right channel number is adjusted through the **Channel L/R** control (see below).

LEFT CHANNEL

When the keyboard is split, only notes to the left of the split point are sent on this channel. When the left channel differs from the right channel, and the keyboard is doubled, all notes are sent on this channel as well as on the right channel. If the left and right channels are the same, data is sent only once. The left channel number is adjusted through the **Channel L/R** control.

ARP. CHANNEL

Reserved for the arpeggiator. When the arpeggiator runs, arpeggiated notes are transmitted on this channel only. As soon as the arpeggiator is latched, and LAYER is off, any notes played on the keyboard are transmitted on the right or left channels.

MIDI MODE

The VS receive mode determines how recognized data is processed. MIDI messages are always sent on the right (base) channel, unless in split or double keyboard mode, or if the arpeggiator is running.

MODE 1

All recognized data is interpreted as if it came from the VS itself. Notes are delegated to available voices, and are treated the same as notes played on the VS keyboard.

MODE 3

In Single mode, the VS accepts data on the right channel only.

In Split or Double mode, the VS can be considered as two separate synthesizers. If the left and right channels are different, then notes, wheels, and program selections received on the left or right channel,

affect the left or right programs independently. In either case, the left and right programs can both play notes over the entire five-octave range.

MODE 4

In Single keyboard mode, the VS accepts data on eight consecutive channels, beginning from the right channel. Each channel plays one voice of the VS like a monophonic synth.

When in Split or Double mode, the left program plays notes received over four consecutive channels starting with the left channel, while the right program plays notes received over four consecutive channels starting with the right channel. Referring to Figure 14-2a, if the left channel is 2, and the right channel is 8, the left program plays notes received on channels 2 through 5, and the right program plays notes received on channels 8 through 11. If the two channel ranges overlap, then only the right program plays notes received on channels common to both ranges (channels 4 and 5 in Figure 14-2b).

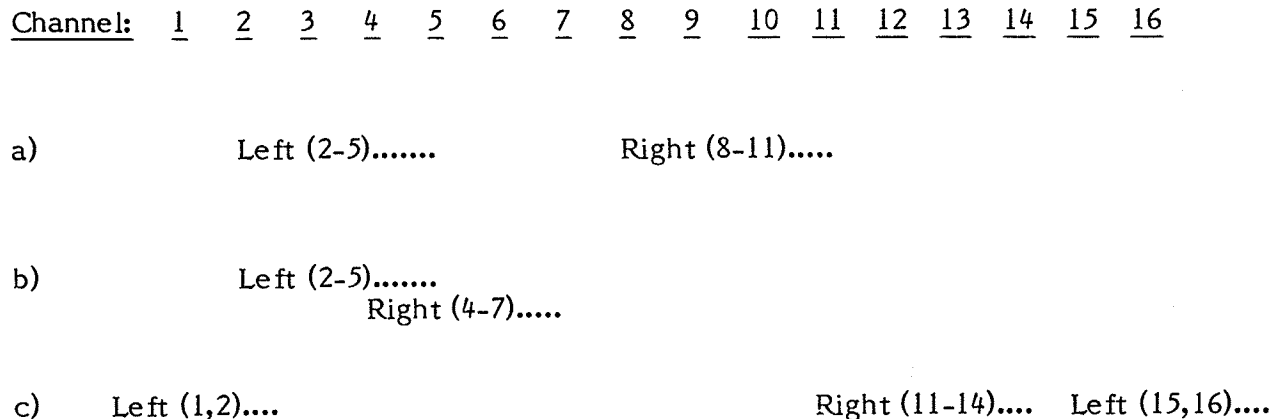

Figure 14-2
MODE 4 CHANNEL RANGES

As Figure 14-2c demonstrates, if the left or right channel is above 13, then channels 1 through 3 are used to complete the four-channel range.

The main advantage of playing the VS in Mode 4 is that voices can respond to individual pitch bend and joystick control if the corresponding options are enabled (these are explained later in this section). These features are especially useful for MIDI guitar controllers transmitting each string on separate channels.

If MIDI control changes (pitch bend, joystick, etc.) are to affect all

voices in Mode 4, then they should be transmitted on the channel just below the left or right channel. For example, in the arrangement shown in Figure 14-2a, control changes sent on channels 1 or 7 will affect all eight voices simultaneously, whereas control changes on channel 8 affect only one voice played by the right program.

If the left and right ranges are adjacent or overlap (as in Figure 14-2b and c), then such "global" control changes should be transmitted on the lowest available channel--minus one channel number. For example, in Figure 14-2b channel 1 should be used and in Figure 14-2c channel 10 should be used.

The VS' MIDI mode is adjusted through the **MIDI Options Select** control.

MULTIPLE-KEYBOARD OPERATION

To send notes to a specific instrument in a MIDI chain, make sure that the slave synths are set to different MIDI channels and mode 3, and that the VS's channels match.

The ARP. CHANNEL is adjusted with the **MIDI Options Select** control (see below).

Figure 14-3 shows typical connection for driving two slaves with a VS. Since both slaves are in Mode 3, and on channels matching the VS's left and right channels, slave #1 always mimics the master, but slave #2 does so only if the VS is in split or double keyboard mode, or if the arpeggiator runs.

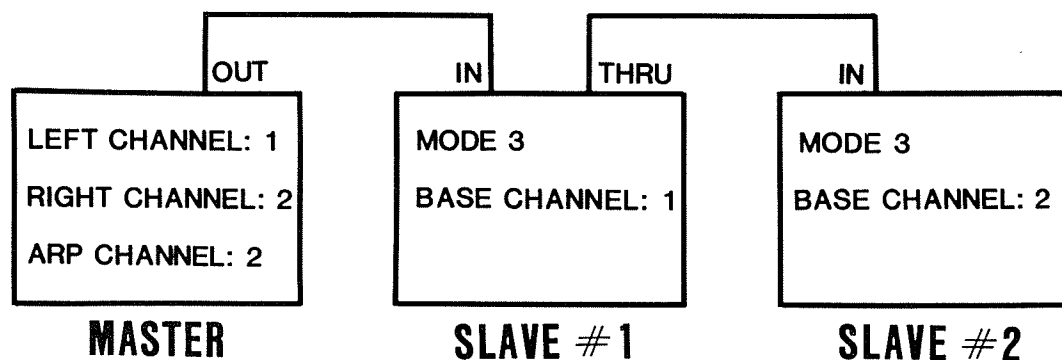

Figure 14-3
MULTI-CHANNEL OPERATION

ARPEGGIATING WITH MIDI

The arpeggiator responds to MIDI notes just as it does to notes played on the keyboard. As explained before, the arpeggiator can transmit notes on a separate channel. Of course, MIDI mode and channel numbers interact as usual, but in addition to note messages, MIDI CLOCK, START, and STOP "real-time" messages (which carry no channel number) are transmitted and recognized.

Clocking the VS with MIDI Drum Machines

Many drum machines transmit drum "events" as their patterns play. These events are usually MIDI notes of very short durations, but just the same, the VS could interpret these as notes intended for the arpeggiator. To avoid this confusion, make sure that drum events are disabled, or transmit on a different channel. (Refer to your drum machine operation manual or MIDIGUIDE.)

The arpeggiator can be programmed to play nearly any size step desirable using the arpeggiator CLOCKS/STEP control (see Section 5). MIDI clocks run at a standard 24 clocks per quarter-note rate. CLOCKS/STEP is continuously variable from 2 to 24. The following chart shows STEP/SIZE values corresponding to common arpeggiator step sizes.

<u>Step Size</u>	<u>CLOCKS/STEP value</u>
Quarter-notes	24
Quarter-note triplets	16
Eighth-notes	12
Eighth-note triplets	8
Sixteenth-notes	6
32nd-note	3

1. Connect drum machine MIDI OUT to the VS's **MIDI IN**.
2. Select the desired drum pattern, song, or sequence.
3. Switch the VS's **On-Off/Rate** on.
4. Move the VS's slider to minimum.

The lower LCD line reads "EXT. CLOCK".

5. Start the drum machine.
6. Use the arpeggiator in the usual manner.

If the arpeggiator is latched before stopping the drum machine, the sequence can be recalled:

1. Press **Latch/Transpose**.
2. Start the drum machine.

Clocking Other MIDI Devices

As mentioned above, when operating from its internal clock, the VS transmits MIDI clocks as it runs. (If it has been set to operate from an external clock, it does not re-transmit this clock.) If the VS is to clock another MIDI device, before starting the VS' arpeggiator, start the other instrument's arpeggiator (sequencer, or whatever).

Notes are accepted over MIDI, so make sure drum events are disabled on the drum machine. (Refer to Sequential's MIDI CONTROL SUMMARY, document number MIDI-5.)

When the arpeggiator is switched off, this transmits a Stop message which automatically will turn off the slave's arpeggiator (sequencer, etc.).

If the VS receives a MIDI Stop message, this turns off notes but leaves the arpeggiator on so it can be restarted.

MIDI OPTIONS

The VS features many MIDI options which allow you to set it up for your specific applications. These options (including the MIDI channel numbers) are stored in non-volatile memory so that even if power is temporarily switched off, their settings are remembered.

Receive Mode

The MIDI modes were discussed earlier. The VS handles the transmission of MIDI data identically for all modes, so the only variable is the manner in which it receives MIDI information. To select the desired mode:

1. Press **MIDI Options Select** until the bottom line of the LCD reads "RECEIVE MODE".
2. Adjust the displayed mode with the slider.
3. If desired, select and adjust other MIDI options (see below).

MIDI Wheels

The Mod wheel position or amount of pitch wheel bend may be enabled for receiving, transmitting or both. To adjust:

1. Press **MIDI Options Select** until the top line of the LCD reads "MIDI WHEELS".
2. Use the slider to select "DISABLED", "TRANSMIT ONLY", "RECEIVE ONLY", or "TRANSMIT + RECEIVE".

Note: The range of transmitted pitch bend is set by the **Pitch Wheel Range** control.

In Mode 4, received pitch bend information affects only selected voices depending on the channel number. Therefore, if the VS is in Split or Double keyboard mode, the left and right programs can be pitch-controlled separately. Similarly, Mod wheel information is common to all voices in each program.

MIDI Programs

Selection of a program on the VS can simultaneously select a program on a "slave" synthesizer. Similarly, the VS can change programs prompted by a received "Program Select" MIDI message. For program selections over MIDI to be successful, the modes and channels of the equipment involved must be correct, and MIDI PROGRAMS must be enabled:

1. Press **MIDI Options Select** until the top line of the LCD reads "MIDI PROGRAMS".
2. Use the slider to select "DISABLED", "TRANSMIT ONLY", "RECEIVE ONLY", or "TRANSMIT + RECEIVE".

If the VS is in Split or Double keyboard mode, and the left and right channels differ, the linked program number is also transmitted, but on the left channel. Similarly, program changes received on the left channel alter the linked program, but not the main program.

If the VS is in Mode 4, then program changes received on any channel within the left or right channel ranges affect the left or right program numbers (respectively).

MIDI Pressure

Although pressure is not implemented on all MIDI equipment, many instruments interpret MIDI pressure as mod wheel information. For keyboard pressure to be successfully sent or received over MIDI, the modes and channels of the equipment involved must be correct, and MIDI PRESSURE must be enabled:

1. Press **MIDI Options Select** until the top line of the LCD reads "MIDI PRESSURE".
2. Use the slider to select "DISABLED", "TRANSMIT ONLY", "RECEIVE ONLY", or "TRANSMIT + RECEIVE".

If the VS is in Split or Double keyboard mode, and the left and right channels differ, then pressure can affect the main and linked programs independently.

In Mode 4, pressure received on any channel within the right or left channel range affects the main or linked program (respectively).

MIDI Joystick

When enabled, the VS transmits joystick movement. When one VS is MIDI'd to another, this ability is very useful. If, however, some other synthesizer is being slaved to the VS, the joystick may need to be disabled over MIDI. (Some instruments may use the same control numbers for other purposes.)

1. Press **MIDI Options Select** until the top line of the LCD reads "MIDI JOYSTICK".
2. Use the slider to select "DISABLED", "TRANSMIT ONLY", "RECEIVE ONLY", or "TRANSMIT + RECEIVE".

If the VS is in Split or Double keyboard mode, and the left and right channels differ, then received joystick information can affect the main and linked programs independently.

In Mode 4, each voice responds to joystick information individually, unless the data is received as "global control" information on the channel immediately below the left or right channel.

MIDI Parameters

All of the VS' parameters may be adjusted over MIDI, just as they are from the front panel. Similarly, the VS can transmit front panel control adjustments to another VS or MIDI-equipped computer. Because these parameters are rarely changed over MIDI, and to avoid possible confusion --should the VS receive parameter change messages from an instrument other than another VS-- MIDI parameters are always disabled on power-up. (Full details on addressing the parameters appear later in this section.)

1. Press **MIDI Options Select** until the top line of the LCD reads "MIDI PARAMETERS".
2. Use the slider to select "DISABLED", "TRANSMIT ONLY", "RECEIVE ONLY", or "TRANSMIT + RECEIVE".

When enabled, the VS transmits parameter changes whenever a parameter is adjusted from the front panel. Parameter changes only affect the main program. The linked program's parameters are unaffected.

Arpeggiator Channel

The VS can transmit notes played by the arpeggiator on a separate channel from notes played live from the keyboard. This is especially useful after latching the arpeggiator. The VS itself will still play all notes played live or arpeggiated.

1. Press **MIDI Options Select** until the bottom line of the LCD reads "ARP. CHANNEL".
2. Use the slider to select the desired channel number (1-16).

The arpeggiator channel number is remembered when power is switched off.

Overflow

The VS has an eight-voice capability. When more than eight keys are held simultaneously, the VS "steals" the oldest voice, and assigns it to the most recent note. When OVERFLOW is on, however, instead of stealing voices, the VS transmits the note over MIDI, so if another VS is being "slaved," then sixteen-voice capability can be achieved. With OVERFLOW on, the VS treats notes played on the keyboard and notes received over MIDI the same. If the slave VS also has OVERFLOW on, yet another VS may be connected, extending the capability to twenty-four voices.

Note: If the VS drives other instruments which also have OVERFLOW on, do not connect the the MIDI output of any of the other instruments to the VS's **MIDI IN**. Also, the last instrument in the chain should have OVERFLOW off.

1. Press **MIDI Options Select** until the bottom line of the LCD reads "OVERFLOW."
2. Switch OVERFLOW on/off with the slider.

To avoid possible confusion, OVERFLOW is always off on power-up.

Program Dump

This option allows the VS to transfer program data (excluding waveform information) to another VS or MIDI-equipped computer.

1. Press **MIDI Options Select** until the top line of the LCD reads "PROGRAM DUMP".
2. Adjust the slider for the desired program number (00-99) or "ALL 100".
3. If necessary, prepare the other MIDI device for the transfer.

4. Press **Enter**.
5. If necessary, dump the waveforms used by the dumped program. (See below.)

Wave Data Dump

If program data is being transferred between two VSs, it is important that the same user waveforms reside in both machines. This does not mean that program dumps will not be successful if waveforms are not the same in both machines, only that the two VSs will not sound the same. If that is your intention, never mind. But if you want to back up your programs over MIDI, then waveform dumps are essential.

1. To determine which waveforms you specifically want to transfer, select the desired program, then examine the **Oscillator Group** settings (or use the Review function).
2. Press **MIDI Options Select** until the top line of the LCD reads "WAVE DATA DUMP".
3. Select the desired wave number (0-31) or "ALL 32".
4. If necessary, prepare the other MIDI device for the transfer.
5. Press **Enter**.

RECEIVING WAVEFORMS FROM MIDI SAMPLERS

The Prophet VS accepts the MIDI Sample Dump Standard format (as explained under the next heading), but only 128 12-bit words of wave data are accepted per waveform. If a sample is sent with more data, only the first 128 words are accepted.

To dump to the VS, you should truncate the sample so that the only thing left is the desired sample loop. (If there is anything before the loop, it will become the wave instead of the loop.)

If a sample loop is not exactly 128 words long, it will either be truncated, or blank bytes will occur. In either case, the resulting VS waveform will be different from the original. For the best conversion from a short sample loop to a VS waveform, specific notes should be sampled. The note you should sample is directly related to the frequency at which it is to be sampled:

<u>Sample Rate</u> (Samples/Sec)	<u>Optimum Frequency</u> (Cycles/Sec)	<u>Nearest Note</u> (Even-tempered)
X	X/128	
15625	122.07031	B1 (123.4708)
31250	244.14063	B2 (246.9417)
41667	325.52084	E3 (329.6276)

MIDI COMMON SAMPLE DUMP STANDARD

At the Summer, 1985 convention of the National Association Music Merchants (NAMM), the members of the MIDI Manufacturer's Association (MMA) and Japanese MIDI Standards Committee (JMISC) discussed, among other things, reserving some System Exclusive codes for future expansion of non-real-time data communication between different manufacturers' equipment. The non-real-time communications are behind System Exclusive Identifier 7E (for example, F0 7E . . . F7). The sample dump standard is the first protocol to be defined under this category.

The sample dump standard is designed for sending one sample at a time between samplers. A unique feature of the system is that it can be used either in open-loop (single cable) or closed-loop (double cable) configurations. In the closed-loop system, "handshaking" improves speed and provides error correction.

The information conveyed is detailed in the transmit and receive specification below, but as it is new, we will take a moment to summarize the system. In general the sample dump is divided into a header followed by a variable number of sample data packets.

The header includes the following information:

Channel number

Sample number (0 -16,383),

Sample format (8 - 28 bit, linear). Notice that the sample format is linear, as are all MIDI controls. Any translation between other DAC formats (for example, COMDAC or delta-modulation) and linear must be done by the MIDI device.

Sample period (1 - 2,097,151 nanoseconds), which translates to a sample rate of 1 GHz to 336 Hz

Sample length (0 - 2,097,151 words), and

Sustain loop points

Sustain loop type (forward only or backward/forward)

The data packet includes:

Channel number

Packet number

120 bytes of data in linear format (which may transfer 60, 40, or 30 sample words, depending on the DAC format). In the Prophet-VS, each packet contains 60 words.

Checksum, for error correction.

In addition, four other messages are used in sample dump communication:

- Sample Dump Request
- Cancel Dump
- Not Acknowledge
- Acknowledge

The data sequence and "handshaking" are as follows.

The master either receives a dump request which includes the sample number, or a dump of the current sample is initiated from the front panel. In either case, the master transmits the header message, and waits for no less than two seconds for the slave to decide if it will accept this dump.

The slave reads the header, and checks the sample characteristics (rate, length, and so on) to see if the sample can be accepted. If the slave will recognize the dump, it sends an Acknowledge. If the slave refuses to accept the dump (for example, due to excessive size or unacceptable rate), it sends a Cancel Dump abort command and returns to normal operation.

If within two seconds a Cancel Dump message is received, the master aborts the dump mode by transmitting an F7 (End of Exclusive), and returns to normal operation. If the master receives the Acknowledge (closed-loop), or if after two seconds it receives nothing (open-loop), it proceeds with the data dump by sending the first data packet, and waits for 20 milliseconds while checking its MIDI input.

The slave receives the packet, checks the packet number to see whether it is a new packet or just a repeat of a previous packet, and compares the checksum at the end. If the checksum matches, the slave transmits an Acknowledge (which means in this case, "The last packet was received okay. Send the next one."). If the checksum does not match, this indicates an error in the packet, so the slave transmits a Not Acknowledge (which means "The last packet had an error. Send it again.") and prepares to receive data. If the slave sends a Not Acknowledge, then sees that the master has incremented the packet number anyway (on the next transmission), it concludes that the master did not receive the Not Acknowledge, so there is an open loop. It may either abort or ignore the error. The Prophet-VS ignores the error.

As soon as the master receives an Acknowledge, it immediately increments the packet number and transmits the next packet. If it received a Not Acknowledge, it keeps the packet number the same and re-transmits the packet. If it receives a Cancel Dump, it will of course abort the dump. If nothing comes in within 20 milliseconds, it proceeds as if an Acknowledge were received.

This keeps going until all of the data has been transmitted. Of course, the sample length will probably not be an even multiple of 120 bytes. In the case of the last packet, the unused portion is to be ignored by

the slave and may even be filled out with garbage by the master (the VS uses zeroes). This is to keep the packets all the same size, which is easier to program.

After the final handshake, the master transmits an F7, and both master and slave return to normal operation.

Note: The above is a general description of how the common sample dump standard operates. Since the Prophet VS is not a sampler, and only deals with small amounts of wave data, "Acknowledge" and "Not Acknowledge" are not implemented.

SPECIFICATION

Note: All values are in hexadecimal unless otherwise noted.

Note: Whenever possible, to save time, the Prophet-VS transmits using running status. This means that if the status byte is unchanged, it is not sent.

<u>Byte</u>	<u>Description</u>	<u>Range</u>	<u>Examples/notes</u>
-------------	--------------------	--------------	-----------------------

CHANNEL

Note Off

8N	N = channel number	0-F	
kk	key number	00-7F	24 is key C1 (lowest)
vv	velocity ignored		

Transmit

Not transmitted. For transmit, 9N with a velocity of 00 is used.

Receive

In Mode 1, channel is ignored.

In Mode 3, Single keyboard, channel number must match the right channel. In this case the message is treated like a local key. In Mode 3 Split or Double, channel number must match base number set for one of the halves. (In Split mode, the channel is split, which in effect gives you two four-voice synthesizers with full-size keyboards.)

In Mode 4, each voice is assigned to a channel. The channels are determined by the RIGHT CHANNEL and LEFT CHANNEL settings. Depending on these settings, it is possible for voices to overlap ranges--which may be desirable in certain applications. While in Mode 4, if a voice which is already off receives another Note Off, it will change to that pitch without retriggering the envelope (legato note off for guitar controllers, etc).

Note Off

9N	N = channel number	0-F	
kk	key number	00-7F	24 is key C1 (lowest)
00	zero velocity		

Transmit

In Mode 1, or Mode 3 or 4 in Single keyboard mode, the channel number equals the right channel. In Modes 3 or 4 with Split or Double modes on, the channel number equals the channel number on the side that the voice involved was assigned to. In Double mode, two Note Offs are sent per key release--once for each side's base channel.

Regardless of the keyboard mode, transmission is a copy of the local keyboard.

Receive

Same as above

<u>Byte</u>	<u>Description</u>	<u>Range</u>	<u>Examples/notes</u>
Note On			
9N	N = channel number	0-F	
kk	key number	00-7F	24 is key C1
vv	velocity	01-7F	

Transmit

Same as Note Off, except Note On.

Receive

Same as above. Note that MIDI keys are not confused with local keys. If MIDI receives the same note number as the local keyboard, a second voice is still assigned.

If in Mode 1 or 3, each Note On message retriggers the voice's envelopes, unless Unison is on, in which case the VS plays legato (pitch changes, but envelopes are not retrigged). If in Mode 4, legato is achieved when no Note Off message is received between two Note On messages on the same MIDI channel.

If the key number is outside of the range shown, it is transposed by octaves back into range.

Key Pressure

AN	N = Channel number
kk	Key number is ignored.
vv	Pressure value

Receive only. Treated like channel pressure. Channel number treated same as MOD wheel.

Mod Wheel Change

BN	N = channel number	0-F	
01	Mod wheel continuous controller		
vv	value	00-7F	00 means Mod wheel off.

Transmit

Successive Mod wheel changes are transmitted without repeating the status byte.

In Mode 1, or Mode 3 or 4 in single keyboard mode, the channel number equals the RIGHT CHANNEL value. In Modes 3 or 4 with Split or Double on, if the left and right channels are different, this message is sent twice.

<u>Byte</u>	<u>Description</u>	<u>Range</u>	<u>Examples/notes</u>
-------------	--------------------	--------------	-----------------------

Mod Wheel Change (continued)

Receive

In Mode 1, channel number is ignored, and the value affects only notes which have been turned on over MIDI.

In Mode 3-Single the channel number must match the RIGHT CHANNEL value. In Mode 3-Split or Double, the channel number must match the RIGHT CHANNEL or LEFT CHANNEL values, then it affects all MIDI voices assigned to that half.

Breath Controller

BN	N = channel number	0-F	
02	breath continuous controller		
vv	value	00-7F	00 means off.

Transmit

Not transmitted.

Receive

Received the same as channel pressure.

Foot Pedal

BN	N = channel number	0-F	
04	foot pedal continuous controller		
vv	value	00-7F	00 means off.

Transmit

Not transmitted.

Receive

Received the same as Mod wheel.

Main Volume

BN	N = channel number	0-F	
07	main volume continuous controller		
vv	value	00-7F	00 means off. 7F means 100% volume

Transmit

Not transmitted.

Receive

Same effect as the front panel control.

<u>Byte</u>	<u>Description</u>	<u>Range</u>	<u>Examples/notes</u>
-------------	--------------------	--------------	-----------------------

Pan LSB

BN	N = Channel number		
2A	Pan LSB continuous controller		
vv	value (00-7F)		

Transmit

Not transmitted.

Receive

In Mode 1 and 3, sets pan parameter (still subject to modulation) of each voice to the same value, similar to the way pitch bend affects pitches of all voices. (Depends on keyboard mode and left and right channel values.) In Mode 4, sets each voice's initial pan position independently.

Pan MSB

BN	N = channel number	0-F	
0A	Pan MSB continuous controller		
vv	value	00-7F	

Treated similar to Pan LSB.

Joystick X-Axis MSB

BN	N = channel number	0-F	
10	X-axis MSB code		
xx	X-axis value	00-7F	

Channel number treated same as MOD wheel.

Joystick X-Axis LSB

BN	N = channel number	0-F	
30	X-axis LSB code		
xx	X-axis value	00-7F	

Joystick Y-Axis MSB

BN	N = channel number	0-F	
11	Y-axis MSB code		
yy	Y-axis value	00-7F	

Joystick Y-Axis LSB

BN	N = channel number	0-F	
31	Y-axis LSB code		
yy	Y-axis value	00-7F	

<u>Byte</u>	<u>Description</u>	<u>Range</u>	<u>Examples/notes</u>
-------------	--------------------	--------------	-----------------------

Alternate Release Footswitch

BN	N = channel number	0-F	
40	hold pedal switch controller (alternate release)		
vv	value	00-7F	00-3F is off 40-7F is on

Transmit and Receive

Channel number treated same as with Mod wheel. Operates same as local footswitch.

Alternate Release Footswitch

BN	N = channel number	0-F	
45	2nd release switch controller		
vv	value	00-7F	00 is off 7F is on

Receive Only

Channel number treated same as MOD wheel. Operates same as local footswitch.

All Notes Off

BN	N = channel number	0-F	
7B	All Notes Off		
00			

Transmit

Not transmitted.

Receive

Channel number treated same as MOD wheel, except that if Omni On, it is ignored (to prevent All Notes Off from cutting off notes on the wrong channels). Turns off all gated voices.

Parameters

Due to the number of parameters on the VS, parameter changes are sent (or recognized) in the following format:

Select Parameter LSB
 Select Parameter MSB
 Data Entry LSB
 Data Entry MSB

<u>Byte</u>	<u>Description</u>	<u>Range</u>	<u>Examples/notes</u>
-------------	--------------------	--------------	-----------------------

Parameter Select LSB

BN	N = channel number		
62	LSB		
pp	parameter number (00-7F). (For parameter numbers, see Table 14-1.)		

Transmit

If enabled, sent whenever a parameter is changed on the VS. Followed by Parameter Select MSB message, and Data Entry bytes. If the parameter adjusted on the VS is a switch bit (see Table 14-1), then Parameter Select messages must be sent before Data Entry bytes. For continuous parameters (levels, rates, etc.), Data Entry messages affect the last parameter selected.

Receive

Affects selected MIDI parameter in the current program only. Parameters must first be selected over MIDI (LSB followed by MSB) before Data Entry bytes can be received (see below).

Parameter Select MSB

BN	N = channel number		
63	MSB		
pp	parameter number (00-01)		

Follows Parameter Select LSB message.

Once the parameter has been selected over MIDI, only Data Entry messages need be sent, unless the parameter selected is one of the switch bytes (see Table 14-1), in which case the parameter bytes are always required before the data bytes.

Data Entry LSB

BN	N = channel number		
26	Data entry LSB		
pp	parameter value (00-7F)		

Always followed by Data Entry MSB message. See Parameter Select, above.

Data Entry MSB

BN	N = Channel number		
06	Data Entry MSB		
pp	parameter value (00-7F)		

May be sent following, or without Data Entry LSB message.

<u>Byte</u>	<u>Description</u>	<u>Range</u>	<u>Examples/notes</u>
-------------	--------------------	--------------	-----------------------

Program Number

CN	N = channel number	0-F	
pp	Program number (00-63), select cartridge (7E), or select internal (7F).		

Transmit

In Mode 1, the channel number equals the RIGHT CHANNEL value. In Modes 3 or 4 program number for each side is sent on the appropriate base channel.

Transmitted with each front panel program select.

Receive

In Mode 1 channel number is ignored. Treated like front panel selection.

In Modes 3 or 4 and single keyboard mode, the channel number must equal the RIGHT CHANNEL value.

In Modes 3 or 4 and Split or Double, if received on right channel, acts as program select. If received in left channel, switches linked program only.

Channel Pressure

DN	N = channel number	0-F	
pp	pressure value	00-7F	

For transmit and receive, channel number treated same as MOD wheel.

Receive

In Modes 3 or 4 with Split or Double on, if the left and right channels are different, pressure affects the current and linked programs separately.

Pitch Wheel Change

EN	N = channel number	0-F	
LS		00-7F	
MS		00-7F	<u>MS LS</u> (Most/Least Significant)

00 00 is full bend down

00 40 is centered wheel

7F 7F is full bend up

Examples are regardless of internal bend scaling.

Receive

Has no effect on arpeggiated notes. Channel number treated same as MOD wheel.

Full 14-bit resolution. Accuracy depends on Pitch wheel range. If full 14 bits not used, left-justify (to bit 6) remaining bits in LSByte.

<u>Byte</u>	<u>Description</u>	<u>Range</u>	<u>Examples/notes</u>
-------------	--------------------	--------------	-----------------------

SYSTEM EXCLUSIVE

Program Dump Request

F0	System Exclusive		
01	Sequential identifier		
00	Program dump		
nn	Program number (00-63), all programs (64), or all waves (7F).		
F7	End of Exclusive		

Program Dump

F0	System Exclusive		
01	Sequential identifier		
0A	Prophet VS identifier		
nn	program number (00-63) or all programs (64)		
data			
F7	End of Exclusive		

Wave Dump

F0	System Exclusive		
01	Sequential identifier		
0A	Prophet VS identifier		
7F	all waves		
data			
F7	End of Exclusive		

Transmits all 32 user waves. To transmit one wave, the common sample dump standard format is used.

Enable All MIDI

F0	System Exclusive		
01	Sequential identifier		
7E	enable all MIDI identifier		
F7	End of Exclusive		

When received, enables all transmit/receive options.

Sample Dump Header

F0	System Exclusive		
7E	Common Non-real-time		
01	Dump header identifier		
aa	channel number (00-0F)		
bb	sample number LSbyte	00-1F	
bb	sample number MSbyte	00	always 00

If the dump is initiated by MIDI request, the request includes the desired sample number. If initiated from the front panel (under MIDI options), the current waveform selected in the WAVE DATA DUMP option is sent.

<u>Byte</u>	<u>Description</u>	<u>Range</u>	<u>Examples/notes</u>
-------------	--------------------	--------------	-----------------------

Sample Dump Header (continued)

cc	sample format	0C	corresponds to twelve bits linear
dd	sample period LSbyte	00-7F	see table below
dd	sample period	00-7F	
dd	sample period MSbyte	00-7F	
	sample	sample	period, period, spread out
	<u>rate, kHz</u>	<u>period, ns</u>	<u>in hex</u> <u>to 7-bit bytes, LSB</u>
			<u>first</u>
	15.625	64000	FA 00 00 74 03
	31.25	32000	7D 00 00 7A 01
	41.667	24000	5D C0 04 3B 01
ee	sample length LSbyte	00-7F	
ee	sample length	00-7F	
ee	sample length MSbyte	00-7F	
ff	sus. loop start LSbyte	00-7F	
ff	sus. loop start	00-7F	
ff	sus. loop start MSbyte	00-7F	
gg	sus. loop end LSbyte	00-7F	
gg	sus. loop end	00-7F	
gg	sus. loop end MSbyte	00-7F	Length, loop start, and loop end points are in words, with the first word in the sample being word 00 00 00.
hh	loop type	0 -1	0 = forwards only 1 = backward/forward
F7	End of Exclusive		

When requested or commanded, the master sends the sample dump header. When sending the header (or data packets) the LCD reads "TRANSMITTING MIDI DATA...."

After sending the header, the master waits for two seconds for the slave to decide if it will accept this dump.

Cancel Dump

F0	System Exclusive
7E	Common Non-real-time
nn	Channel number (00-0F)
7D	Cancel Dump
00	Packet number
F7	End of Exclusive

After the slave reads the sample dump header, if it decides not to accept the dump, it sends the Cancel Dump command.

<u>Byte</u>	<u>Description</u>	<u>Range</u>	<u>Examples/notes</u>
-------------	--------------------	--------------	-----------------------

Dump Data Packet

ii	channel number (00-0F)		
jj	packet number (equals 60 words)	00 - 7F	Running packet count. Starts at 00, increments with each new packet. After 7F, resets to 00.
kk x120	120 bytes of actual sample. (equals 60 words)		

Each MIDI byte holds seven bits. Therefore two bytes are required to transmit a twelve-bit Prophet VS sample word. Words are sent left-justified, MSbyte first, unused bits reset to 0: 0xxx xxxx 0xxx xx00.

the final packet still contains 120 bytes, regardless of how many significant bytes actually remain. Unused bytes in the packet are filled out with zeroes.

ll	checksum	00 - 7F	The checksum is is an Exclusive-OR of the previous 120 data bytes.
----	----------	---------	--

The master dumps the data packet under one of two conditions: 1) in the closed-loop system, receiving an Acknowledge message, or 2) in the open-loop system, receiving nothing for two seconds after sending the header.

After sending the data packet, the master waits for 20 milliseconds while checking MIDI IN. If a Not Acknowledge is received, it resends the previous packet. If Acknowledge is received, it immediately starts sending the next packet. If nothing is received within this period, it assumes open-loop conditions, proceeds as if an Acknowledge were received. Namely, it increments the packet number and sends the next packet.

(F7) End of Exclusive

After successful transmission of the final packet, and the final handshake (if closed loop), the master transmits an F7, and both machines go back to normal operation.

<u>Byte</u>	<u>Description</u>	<u>Range</u>	<u>Examples/notes</u>
-------------	--------------------	--------------	-----------------------

System Real-Time

Timing Clock

F8 Transmitted every 96th note that the arpeggiator is clocked. MIDI timing clocks are not echoed.

Start

FA Sent when the arpeggiator is started from front panel. Does not substitute for an F8 (see above).

Stop

FC Sent whenever the arpeggiator is stopped from front panel.

Continue

FB When received, the arpeggiator continues playing from wherever it was stopped.

TABLE 14-1
MIDI Parameters

<u>Parameter</u>	<u>Range</u>	<u># of Bits</u>	<u>MIDI Parameter #</u>	
			<u>MSB</u>	<u>LSB</u>
Oscillators				
Wave # A	0-127	7	00	00
Wave # B	0-127	7	00	01
Wave # C	0-127	7	00	02
Wave # D	0-127	7	00	03
Coarse Freq A	0-24	5	00	04
Coarse Freq B	0-24	5	00	05
Coarse Freq C	0-24	5	00	06
Coarse Freq D	0-24	5	00	07
Fine Freq A	0-99	7	00	08
Fine Freq B	0-99	7	00	09
Fine Freq C	0-99	7	00	0A
Fine Freq D	0-99	7	00	0B
Filter				
Filter Cutoff	0-99	7	00	0C
Resonance	0-99	7	00	0D
Filter Env Amount	0-99	7	00	0E
LFO 1 and LFO 2				
LFO 1 Shape	0-4	3	00	0F
LFO 2 Shape	0-4	3	00	10
LFO 1 Rate	0-99	7	00	11
LFO 2 Rate	0-99	7	00	12
Amplifier Envelope				
Rate 1	0-99	7	00	13
Rate 2	0-99	7	00	14
Rate 3	0-99	7	00	15
Rate 4	0-99	7	00	16
Rate 4A	0-99	7	00	17
Level 0	0-99	7	00	18
Level 1	0-99	7	00	19
Level 2	0-99	7	00	1A
Level 3	0-99	7	00	1B
Loop	0-6	3	00	1C
Repeat	0-7	3	00	1D
Filter Envelope				
Rate 1	0-99	7	00	1E
Rate 2	0-99	7	00	1F
Rate 3	0-99	7	00	20
Rate 4	0-99	7	00	21
Rate 4A	0-99	7	00	22
Level 0	0-99	7	00	23
Level 1	0-99	7	00	24
Level 2	0-99	7	00	25

TABLE 14-1 (continued)

<u>Parameter</u>	<u>Range</u>	<u># of Bits</u>	<u>MIDI Parameter #</u>	
			<u>MSB</u>	<u>LSB</u>
Level 3	0-99	7	00	26
Level 4	0-99	7	00	27
Loop	0-6	3	00	28
Repeat	0-7	3	00	29
Mix Envelope				
Rate 1	0-99	7	00	2A
Rate 2	0-99	7	00	2B
Rate 3	0-99	7	00	2C
Rate 4	0-99	7	00	2D
Rate 4A	0-99	7	00	2E
X Level 0	+/-0-63	7	00	2F
X Level 1	+/-0-63	7	00	30
X Level 2	+/-0-63	7	00	31
X Level 3	+/-0-63	7	00	32
X Level 4	+/-0-63	7	00	33
Y Level 0	+/-0-63	7	00	34
Y Level 1	+/-0-63	7	00	35
Y Level 2	+/-0-63	7	00	36
Y Level 3	+/-0-63	7	00	37
Y Level 4	+/-0-63	7	00	38
Loop	0-6	3	00	39
Repeat	0-7	3	00	3A
Modes				
Keyboard Mode	0-2	2	00	3B
Split Point	0-127	7	00	3C
Link Program	0-99	7	00	3D
Double-Mode Detune	0-31	5	00	3E
Double-Mode Delay	0-127	7	00	3F
Unison Detune	0-7	3	00	40
Glide	0-99	7	00	41
Chorus Right/Left	0-3	2	00	42
Chorus Rate	0-99	7	00	43
Chorus Depth	0-99	7	00	44
Program Volume	0-99	7	0	45
8 Voice Pan				
Locations	+/-0-63	(7X8) 56	00	46-4D
Name	0-31	(5X8) 40	00	4E-55
Arpeggiator				
Rate	0-99	7	00	56
Mode	0-2	2	00	57
Scan	0-5	3	00	58
Octaves	0-3	2	00	59
Repeats	0-3	2	00	5A
Split	0-3	2	00	5B
Voicing	0-1	1	00	5C
Velocity	0-1	1	00	5D
Layer	0-1	1	00	5E
Rest	0-1	1	00	5F

TABLE 14-1 (continued)

<u>Parameter</u>	<u>Range</u>	<u># of Bits</u>	<u>MIDI Parameter #</u>	
			<u>MSB</u>	<u>LSB</u>
Modulation				
LFO 1 Amount	0-99	7	00	60
LFO 2 Amount	0-99	7	00	61
Pressure Amount	+/-0-99	8	00	62
Velocity Amount	+/-0-99	8	00	63
Keyboard Amount	+/-0-99	8	00	64
Filter Env Mod Amt	+/-0-99	8	00	65
Switch Bits:				
LFO 1 Destination		10	01	00-09
LFO 2 Destination		10	01	10-19
Pressure Destination		14	01	20-2D
Velocity Destination		5	01	30-34
Keyboard Destination		4	01	40-43
Filter Env Destination		2	01	50-51
Mod Wheel Destination		3	01	60-62

SECTION 15

PROGRAM AND WAVEFORM DESCRIPTIONS

INTRODUCTION

The Prophet VS presents new possibilities for synthesizer players and programmers alike. The intention of this section is to examine some of these unique capabilities through the factory programs. This document is divided into three sections:

1. Factory Program List.

The VS's factory programs demonstrate many of this instrument's sonic capabilities.

2. Program Explanations.

Due to the complexity of each program it is not practical to describe all one hundred programs. Instead, explanations are provided for eight programs which highlight some of the VS's unique features.

3. ROM Waveform List.

This list describes some of the waveforms residing in the VS's internal ROM. You may use this list for reference while creating or editing programs. Although not all waveforms are used in the factory programs, and detailed comments are not provided for most waveforms, please consider this an invitation to experiment. The uses for any waveform depends largely on the imagination and experience of the programmer, and Sequential welcomes your comments on programming methods for the VS.

PROPHET VS PROGRAM LIST

00	ZENNY1	26	FILGLASS
01	CHOIR 1	27	PINGPONG
02	PACBELL	28	CARIBEAN
03	VOLKANIK	29	ZX4
04	STRING 1	30	VSI SWEEP
05	FEEDBACK	31	ELFIN
06	DIGIMBA	32	ZARG
07	COMPBASS	33	CHIFF 1
08	STEEL DR	34	TRIAD
09	REVERB	35	SQUARES
10	ORGAN 1	36	SLOWBELL
11	VOCAL 1	37	ZENNY 2
12	REPEATER	38	ROADSY 1
13	JAZGITAR	39	NORCHTRA
14	STRING 2	40	IS THERE
15	DIGICLAV	41	ANAHORN
16	RONZONI	42	WARLOX
17	TWANGBA3	43	MASS 2
18	KEYVEX	44	SATIR
19	ELECDRUM	45	SASINSAM
20	E PIANO1	46	CLAVIBEL
21	CARLOS	47	COMPBAS2
22	LOOP 1	48	CHOIRBEL
23	HEAVY 1	49	AMBIENCE
24	FILSTRING	50	THING
25	MASS 1	51	WOODWIND

52	GASEOSA	76	ARNOUD
53	WEEPY	77	TWANGBA4
54	FRIPPINO	78	RESBASS
55	WROKROCK	79	ELECDRM2
56	HARLOOP	80	ORGAN 2
57	TAKBASS	81	ROVING
58	WOODMETL	82	BELTONE1
59	ACIDRAIN	83	BLUNTOBJ
60	ZANG	84	ANAGLIDE
61	GLASSHRN	85	BELTONE2
62	STEWKEY	86	XWANG
63	TAKATTAK	87	CLACY
64	SPACE	88	SAMPHOLD
65	KALIMBA	89	ELYSE
66	PERKEY 1	90	PIPE ORG
67	TABLOID	91	NITEMARE
68	ORGIZM	92	VECTORFX
69	FILMUSIC	93	SOUND FX
70	CHINABL1	94	DADADUM
71	SYNHORN	95	FILTERFX
72	VIBRELES	96	CHINABL2
73	EMARIMBA	97	TWANGBAS
74	TECHOIRD	98	FILTRES
75	DIGIDUDE	99	TOYPLANE

VOICE CONTROLS

Unison/ Detune	Glide	Program Volume
5	0	20

PROPHET VS PROGRAM # 03

VOLKANIK

KEYBOARD MODE

Split	Split Key	Link #	Double	Detune	Delay
OFF	C3	03	OFF	13	240

LFO GROUP

	Shape	Rate
LFO 1	^	12
LFO 2	^	13

CHORUS

Left	Right	Rate	Depth
ON	ON	30	53

VOICE PAN

Voice 1	Voice 2	Voice 3	Voice 4	Voice 5	Voice 6	Voice 7	Voice 8
-63	-45	-26	-10	+9	+27	+46	+63

ARPEGGIATOR

Rate	Mode	Scan	Octaves	Repeats	Split	Voicing	Velocity	Layer	Rests
88	AUTO L	ASSIGN	1	1	OFF	POLY	ON	OFF	ON

MODULATION

Source	Amount	Freq	Filter	Mix	LFO 1	LFO 2	Amp	Pan	Chorus
LFO 1	82			A-C		RATE AMT		ON	
LFO 2	83			B-D	RATE AMT			ON	
Pressure	+51					RATE			
Velocity	0								
Keyboard	-13		ON						
Filter Env									
Mod Wheel					AMT	AMT			DEPTH

OSCILLATOR GROUP

Oscillator	Wave#	Freq
A	40	00.00
B	41	00.00
C	42	00.00
D	42	00.00

MIX ENVELOPE

Point	Rate	Level
0	/	0/0/0/100
1	50	0/100/0/0
2	50	0/51/49/0
3	50	1/4/81/14
4	50	26/30/24/20
4A	76	/

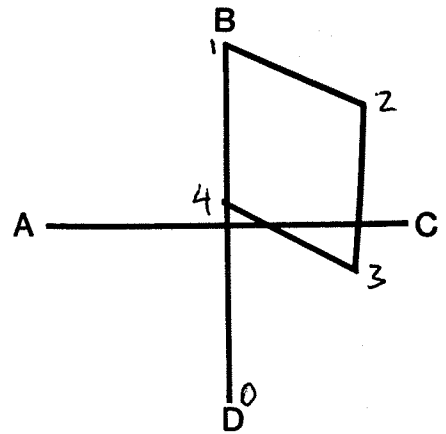

Loop	Repeat
0 ↔ 3	C

FILTER ENVELOPE

Point	Rate	Level
0	/	0
1	0	87
2	42	0
3	0	43
4	0	0
4A	77	/

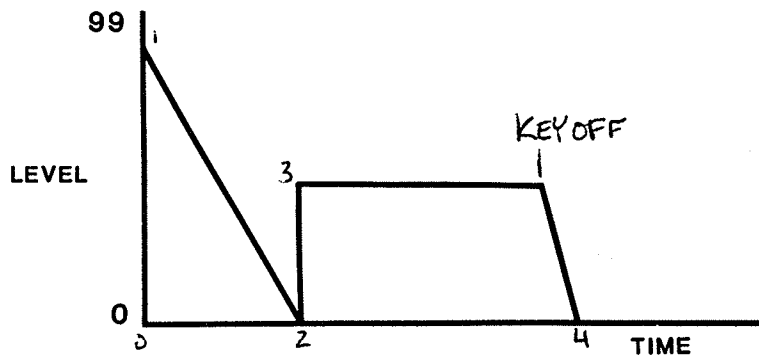

Loop	Repeat
OFF	

FILTER GROUP

Cutoff	Resonance	Env Amount
99	0	0

AMP ENVELOPE

Point	Rate	Level
0	/	0
1	36	99
2	36	70
3	35	99
4	92	0
4A	97	/

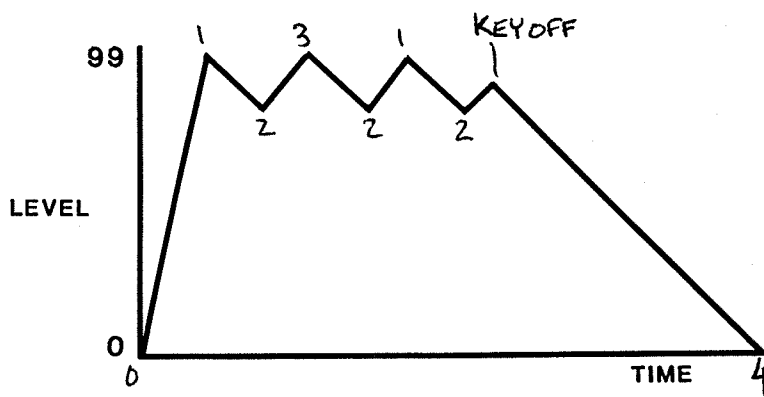

Loop	Repeat
1 ↔ 3	C

VS VOLKANIK (35)

This is a fairly awesome stereo sound when played at high volumes and at the low end of the keyboard.

Keyboard Mode

The keyboard is in Single keyboard mode. And we notice right away that it is also in Unison mode, because only one key can be heard at a time. Selecting **Unison/Detune** confirms this. To see what an enormous effect voice stacking and detuning has on this sound, reduce the detuning value and then switch **Unison/Detune** off. The patch definitely loses its character as detuning is reduced below "4". When Unison is off, the patch sounds only like a fat organ.

Oscillator Group

The **Oscillator Select** switch tells us that oscillator A uses wave 40, oscillator B uses 41, and C and D both use wave 42. Waveform #41 has a harsh quality compared to the simpler waveforms #40 and 42 and brings a shrill timbre to the program whenever the mixer envelope accentuates oscillator B. There are no coarse or fine frequency adjustments. All oscillators are tuned to the same basic pitch, so there is no beating between the oscillators.

Filter

Cutoff is 99, which essentially means that the filter is not being used. This allows the full harmonic spectrum from the mixer to pass to the amplifier.

Envelope Group

First let's survey the vectors in the mixer envelope. It begins at point 0 with 100% of Osc D (wave 42). It moves to point 1, which is 100% Osc B (wave 41). Point 2 is located half way (51/49) between Osc B and C (waves 41 and 42). Point 3 emphasizes Osc C, while the envelope releases (point 4) to a fairly even mixture of the four waves.

The rates of each of the vectors is the same: 50. A continuous back/forward loop has been set between points 3 and 0. So, what we have is a continuous, but asymmetric dynamic mix between essentially two waves (42 and 41).

We are not concerned with the filter envelope, because **Cutoff** is already maximum, and the filter **Env Amount** is set to 0.

The amplifier envelope is set up for a medium-rate tremolo. The first three segments all have the same rate. Points 1 and 3 are equal in level (99), and point 2 is a little less (70). With a continuous loop between points 3 and 1, a triangle wave is thereby formed, so the amplifier level is made to steadily decrease and increase.

LFO Group

Both LFOs are set for triangle waves, and have almost the same rates (12 and 13). This difference is not accidental: small adjustments like this add motion through low-frequency "beating." We will want to see how the LFOs are routed through the **Modulation** module.

Modulation

Setting **Source Select** to LFO 1, we then press **Destination Select** to find that LFO 1 is modulating the A-C mixer axis, as well as the rate and amount of LFO 2. LFO 2, in turn, is modulating the B-D axis as well as the rate and amount of LFO 1. Both LFOs modulate the panning of each voice.

The LFOs are therefore cross-coupled--each controlling the other at a slightly different rate. This feedback produces a constant change in the LFO rates, which is coupled to both the oscillator mixer and the voice pan system--because LFO 2 also has this destination.

Although some of the other modulation sources are routed, they do not actually contribute significantly to the patch.

Voice Control

Unison/Detune was discussed above. **Glide** is not used, and **Program Volume** is set to 20 so that this program won't overwhelm the others. If you want, you can make it a lot louder.

Cycle through the **Voice Pan** setups and you will find the initial position of the voices to be evenly distributed within the stereo field. With the LFO modulation, voices pan continuously between the left and right outputs, yet rarely are all voices panned entirely to either output.

Chorus

Both **Chorus** channels are on. **Rate** is set to minimum, which adds a doubling effect to the eight voices already playing in unison. For more motion, increase **Rate**.

In summary, this patch results from the interaction of up to five separate and independent dynamic actions:

- Oscillator mixer sweep by mixer envelope and LFOs.
- Amplifier envelope tremolo.
- LFO rate and amount modulation.
- LFO voice panning.
- Unison/Detune** and **Chorus**.

VOICE CONTROLS

PROPHET VS PROGRAM # 49

Unison/ Detune	Glide	Program Volume
OFF	0	20

AMBIENCE

KEYBOARD MODE

Split	Split Key	Link #	Double	Detune	Delay
OFF	F#3	06	OFF	0	0

LFO GROUP

	Shape	Rate
LFO 1	^	10
LFO 2	^	14

CHORUS

Left	Right	Rate	Depth
ON	ON	30	72

VOICE PAN

Voice 1	Voice 2	Voice 3	Voice 4	Voice 5	Voice 6	Voice 7	Voice 8
+49	+36	+8	-32	-26	-3	+24	0

ARPEGGIATOR

Rate	Mode	Scan	Octaves	Repeats	Split	Voicing	Velocity	Layer	Rests
81	EXT	ASSIGN	1	1	DUAL	POLY	ON	ON	ON

MODULATION

Source	Amount	Freq	Filter	Mix	LFO 1	LFO 2	Amp	Pan	Chorus
LFO 1	85			B-D					
LFO 2	67							ON	
Pressure	+31				RATE	RATE			
Velocity	+99		ENV	A-C					
Keyboard	0								
Filter Env	0								
Mod Wheel					AMT	AMT			

OSCILLATOR GROUP

Oscillator	Wave#	Freq
A	32	24.00
B	42	00.00
C	41	00.00
D	32	12.00

MIX ENVELOPE

Point	Rate	Level
0	/	0/0/17/83
1	41	26/32/24/18
2	30	0/100/0/0
3	70	0/9/9/0
4	62	0/0/0/100
4A	85	/

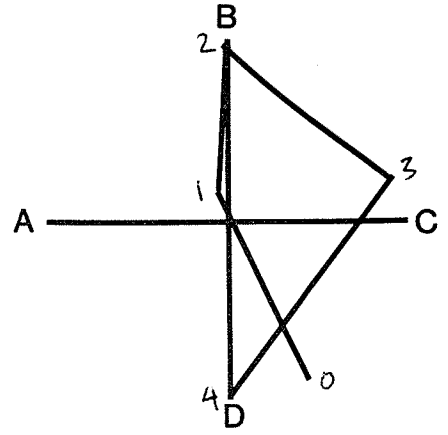

Loop	Repeat
OFF	

FILTER ENVELOPE

Point	Rate	Level
0	/	99
1	8	64
2	14	50
3	25	23
4	75	0
4A	81	/

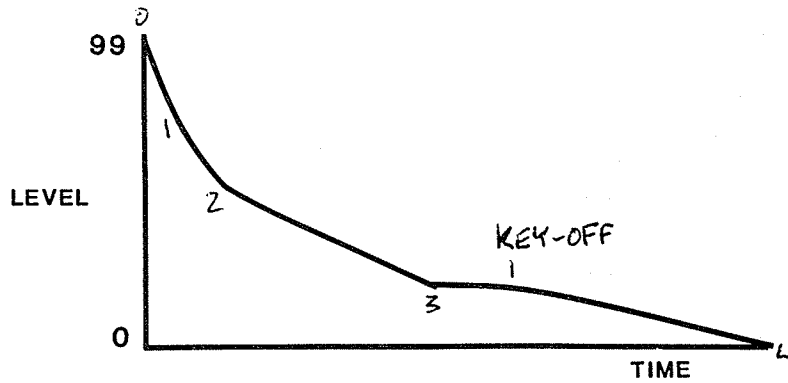

Loop	Repeat
OFF	

FILTER GROUP

Cutoff	Resonance	Env Amount
43	0	0

AMP ENVELOPE

Point	Rate	Level
0	/	0
1	5	99
2	16	75
3	0	75
4	80	0
4A	86	/

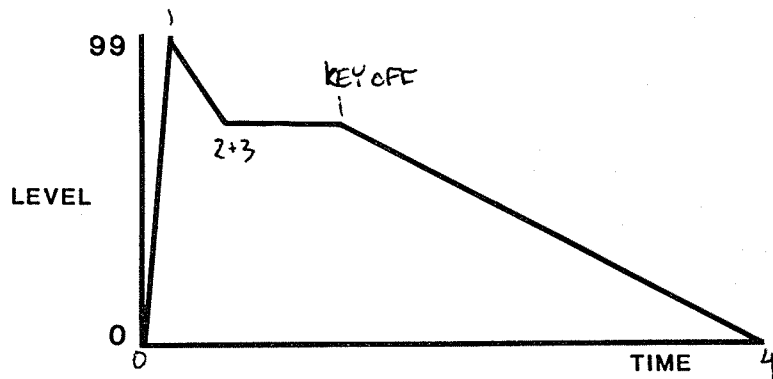

Loop	Repeat
OFF	

VS AMBIENCE (49)

This patch uses just a few routings to produce a responsive yet quite liquid and airy effect. If it is delayed with respect to another program in Double mode, the notes will tend to sound as if they are returning from a reverberant room. The long release time suggests a drone on the octaves of notes played.

Keyboard Mode

The program itself is in Single mode. However, the nature of the program makes it especially useful for layering with a wide variety of programs, in Double mode. For Double mode, whether you choose this program as the current program or as the linked program will depend on which program you want to delay or detune. (The linked program is the one that is delayed or detuned with respect to the current program.) Try linking this sound to other programs in the same manner as program #09 "REVERB."

Oscillator Group

Using the oscillator Select switch tells us that:

- Osc A uses wave 32 (sine wave), tuned two octaves up (24.00).
- Osc B uses wave 42 (thin, sharp tone), at base pitch (00.00).
- Osc C uses wave 41 (shrill tone with ninth harmonic), also at base pitch.
- Osc D uses wave 32 (sine wave), tuned one octave up (12.00).

With oscillators A and D producing sine waves, this program depends mostly on oscillators B and C to produce harmonic motion.

Filter Cutoff is 43, which sets a medium tone. Since the timbre is so velocity-sensitive, we suspect that the filter is also being modulated by velocity, and a glance at the modulation section will confirm this.

Envelope Group

Point 0 is an 83/17 mix of Osc D and C. The beginning of the note therefore receives little harmonic contribution from oscillator C.

As the mixer envelope slowly passes through points 1 and 2, oscillators B and C provide high order harmonics. Oscillator A is brought up in the mix, though only briefly, and scarcely noticeably. The shift from oscillator D to oscillators B and C as the envelope progresses towards point 3 produces an effect similar to that of a low-pass filter being "swept open," although the resemblance ends there as the shift from oscillator B to oscillator C produces a shimmering effect. Since the mixer looping is off, the mixer continues to produce the 9/91 mix of oscillators B and C until the key is released.

When the key is released, the mixer envelope slowly returns towards oscillator D, until all that is heard is a sine wave at an octave above concert pitch.

So now you know why this sound is so light: The lowest pitches (fundamentals 1 and 2) only appear after the note has been held for about a second. Listen to the patch now with this information in mind, and you should be able to more clearly hear the lower pitches fading in.

Because of the de-emphasis of the fundamental pitches at the start of the envelope, this program can almost be considered to be already transposed an octave upwards. In fact, comparing this program to some others will tell you that during most of the note, it in fact does sound an octave high. When played stacatto, the mixer point does not move as far from oscillator D, and this effect is even more noticeable.

We are not concerned with the filter envelope, because the filter **Env Amount** is set to 0.

The amplifier envelope is simple: there is a quick attack from 0 to 99 (point 1), followed by a decay to 75 (points 2 and 3). The rate 4 value of 80 gives a release long enough for the mixer envelope to complete its final stage.

Modulation

LFO 1 is set for a slow triangle wave, and is modulating the B-D mixer axis. In other words, it is mixing a fundamental with an octave pitch. The effect is subtle, but important to the sound. To hear the LFO modulation more clearly, increase **LFO 1 Rate**.

LFO 2 is also set for a slow triangle wave, and is panning the voices. Here again the programmed effect is subtle and can be made more obvious by increasing the source depth and rate.

Velocity is routed to the filter envelope amount, which, of course, makes slow notes dull and fast notes bright. But at the same time, velocity is also applied to the mixer A-C axis. A high positive velocity drives the mixer point towards Osc C, bringing out the complex harmonic structure of waveform #41. This contributes significantly to the reedy sound produced by a fast key attack.

Voice Control

Unison/Detune and **Glide** are not used. **Program Volume** is set to a low 20, which -- combined with the long release of the program-- lets it mix well with other programs. If desired, you can quickly add velocity control over volume by simply switching on the VELOCITY source to AMP ENV destination path.

Cycle through the **Voice Pan** setups and you will find the initial position of the voices distributed within the stereo field. These are the positions from which each voice is modulated by LFO 2.

Chorus

And finally, as will usually be the case with "airy" patches of this type, both **Chorus** channels are on. **Rate** and **Depth** are set to medium.

VOICE CONTROLS

Unison/ Detune	Glide	Program Volume
OFF	0	50

PROPHET VS PROGRAM # 08

STEEL DRUM

KEYBOARD MODE

Split	Split Key	Link #	Double	Detune	Delay
OFF	C#3	28	OFF	0	0

LFO GROUP

	Shape	Rate
LFO 1	^	70
LFO 2	^	63

CHORUS

Left	Right	Rate	Depth
ON	ON	88	6

VOICE PAN

Voice 1	Voice 2	Voice 3	Voice 4	Voice 5	Voice 6	Voice 7	Voice 8
0	0	0	0	0	0	0	0

ARPEGGIATOR

Rate	Mode	Scan	Octaves	Repeats	Split	Voicing	Velocity	Layer	Rests
91	AUTO	UP	1	1	OFF	POLY	ON	OFF	ON

MODULATION

Source	Amount	Freq	Filter	Mix	LFO 1	LFO 2	Amp	Pan	Chorus
LFO 1	0	A, B, C+D							
LFO 2	0								
Pressure	0								
Velocity	+50		ENV				ENV		
Keyboard	+12		ON						
Filter Env	0								
Mod Wheel					AMT	AMT			

OSCILLATOR GROUP

Oscillator	Wave#	Freq
A	35	00.00
B	32	00.00
C	33	00.00
D	114	00.14

MIX ENVELOPE

Point	Rate	Level
0	/	95/5/0/0
1	14	32/22/19/27
2	9	0/0/28/72
3	18	0/0/20/78
4	78	20/22/31/78
4A	70	

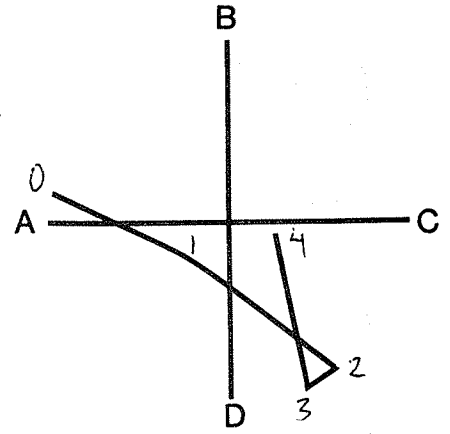

Loop	Repeat
OFF	

FILTER ENVELOPE

Point	Rate	Level
0	/	0
1	5	76
2	21	59
3	36	38
4	58	0
4A	67	/

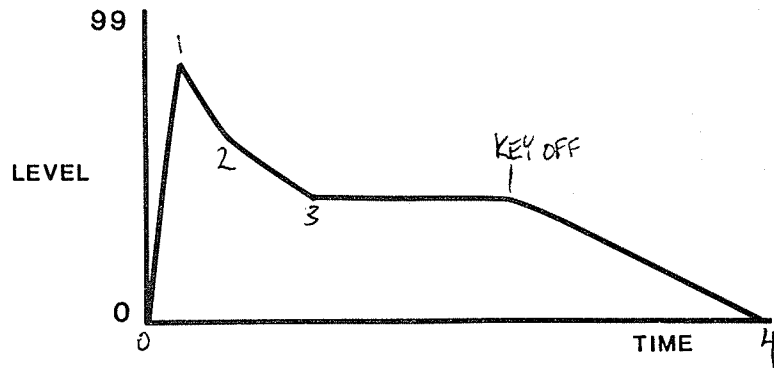

Loop	Repeat
OFF	

FILTER GROUP

Cutoff	Resonance	Env Amount
46	5	6

AMP ENVELOPE

Point	Rate	Level
0	/	0
1	0	80
2	10	75
3	40	0
4	51	0
4A	66	/

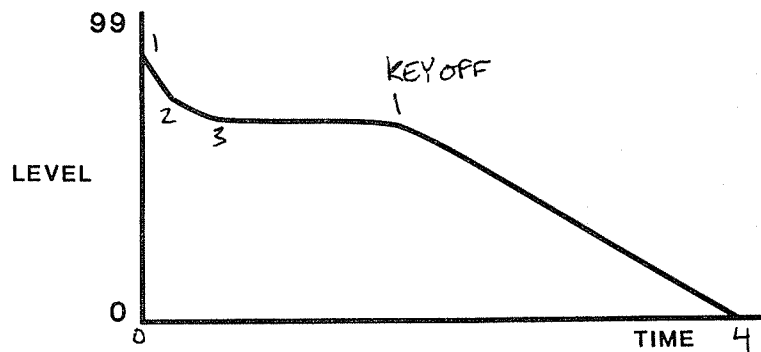

Loop	Repeat
OFF	

STEEL DRUM (#16)

This program makes good use of the mixer envelope to produce a steel drum sound which is consistent across the VS's 5-octave keyboard. Velocity modulation of the oscillator mix adds to the program's realism by controlling the "metallic" component of the sound.

Keyboard Mode

The program is in Single mode, although it doubles nicely with program #24 "CARIBBEAN."

Oscillator Group

Oscillator A uses wave #35, which emphasizes the tenth harmonic. Oscillators B and C use waveforms #32 (sine wave) and #33 (sawtooth), neither of which emphasize one harmonic more than the fundamental. Oscillator D uses waveform #114 which contains healthy amounts of the eighth and thirteenth harmonics.

Filter

The filter cutoff is set low, allowing the filter envelope to drive it higher with increasing key velocity. To help accentuate the cutoff frequency as it is swept by the envelope, Resonance is set to 5.

Envelope Group

The mixer envelope moves quickly --and in roughly a straight line-- from oscillator A to a blend of oscillators C and D. Oscillator B, is brought up in the mix momentarily as the envelope moves through point 1, but makes little contribution to the program as it produces a sine wave at concert pitch. On the other hand as points 2 and 3 (virtually identical) are approached, the detuned eighth harmonic produced by oscillator D beats against oscillator C, which is at concert pitch. As the filter cutoff rises with increasing key velocity, the thirteenth harmonic present in oscillator D becomes more evident, and the program takes on a metallic quality.

When keys are released, and the mixer envelope enters its final stage, the mix gradually approaches a balance between all oscillators, and the program's tone becomes smoother.

Both the amplifier and filter envelopes are set for percussive initial decays to point 3 (sustain level), but the filter envelope has a slightly slower attack, delaying the entrance of oscillator A's tenth harmonic before the mixer envelope shifts the emphasis to oscillators C and D.

LFO Group

Both LFOs are triangle waveforms at similar rates, but only LFO 1 is used in the Modulation group.

Modulation

LFO 1 is set to modulate the pitch of all four oscillators, but as its initial source amount is zero, the extent of its effect is controlled by the modulation wheel.

Velocity is set for positive modulation of the filter and amplifier envelope amounts. Hence, the harder a key is played, the louder the sound is produced --along with increased amounts of the detuned thirteenth harmonic (which adds to the program's metallic sound).

A small amount of keyboard modulation of the filter cutoff frequency evens the tone of the program across the keyboard.

Voice Control

Program Volume is set at 50, as is the velocity modulation source amount, allowing key velocity to drive the volume to its maximum. **Unison** and **Glide** are both off, and all voices are panned to the center. Should you want to arpeggiate with this program, rearranging the voices in the stereo image would produce lively, constant motion.

Chorus

The chorus is used in a somewhat unconventional manner. The rate is set quite high, and the depth is very low. This causes a subtle trembling of the oscillators that is not apparent at first. If desired, adjust **Chorus Amount** for a more exaggerated effect.

In short, this program demonstrates how different waveforms may be detuned, and dynamically-mixed subtly for convincing effects, and how the chorus may be used for other purposes than thickening the sound.

VOICE CONTROLS

PROPHET VS PROGRAM # 33

CHIFF

Unison/ Detune	Glide	Program Volume
OFF	0	20

KEYBOARD MODE

Split	Split Key	Link #	Double	Detune	Delay
OFF	D#3	36	OFF	0	0

LFO GROUP

	Shape	Rate
LFO 1	^	73
LFO 2	^	71

CHORUS

Left	Right	Rate	Depth
ON	ON	31	44

VOICE PAN

Voice 1	Voice 2	Voice 3	Voice 4	Voice 5	Voice 6	Voice 7	Voice 8
0	0	0	0	0	0	0	0

ARPEGGIATOR

Rate	Mode	Scan	Octaves	Repeats	Split	Voicing	Velocity	Layer	Rests
81	NORM	ASSIGN	1	1	OFF	POLY	OFF	OFF	OFF

MODULATION

Source	Amount	Freq	Filter	Mix	LFO 1	LFO 2	Amp	Pan	Chorus
LFO 1	0	B, D							
LFO 2	0	A, C							
Pressure	+52				AMT	AMT			
Velocity	+84		ENV				ENV		
Keyboard	+26		ON						
Filter Env	0								
Mod Wheel					AMT	AMT			

OSCILLATOR GROUP

Oscillator	Wave#	Freq
A	NOISE	/
B	32	12.00
C	32	19.00
D	32	00.00

MIX ENVELOPE

Point	Rate	Level
0	/	99/1/0/0
1	11	4/24/63/9
2	41	0/0/35/65
3	13	0/0/28/72
4	27	0/11/89/0
4A	27	/

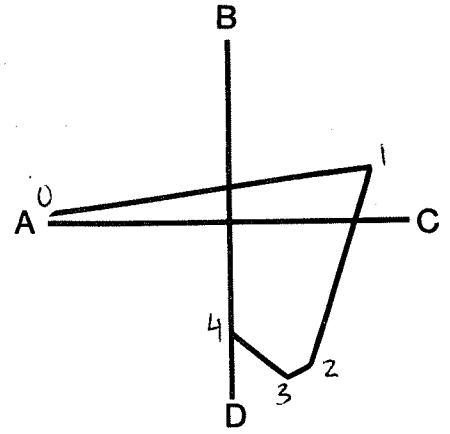

Loop	Repeat
OFF	

FILTER ENVELOPE

Point	Rate	Level
0	/	0
1	0	99
2	3	0
3	0	0
4	0	0
4A	76	/

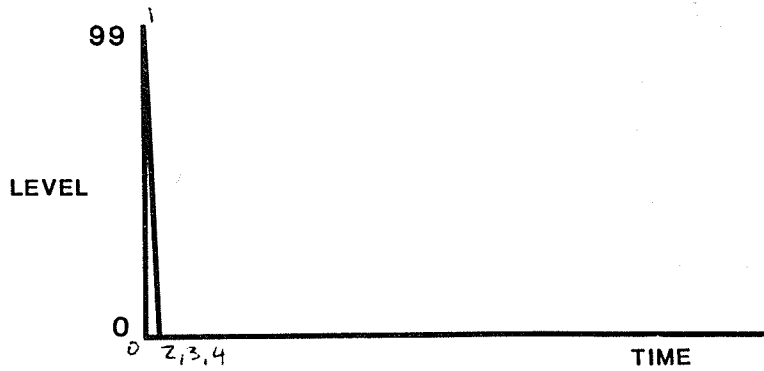

Loop	Repeat
OFF	

FILTER GROUP

Cutoff	Resonance	Env Amount
62	0	0

AMP ENVELOPE

Point	Rate	Level
0	/	0
1	3	99
2	0	99
3	0	99
4	0	0
4A	70	/

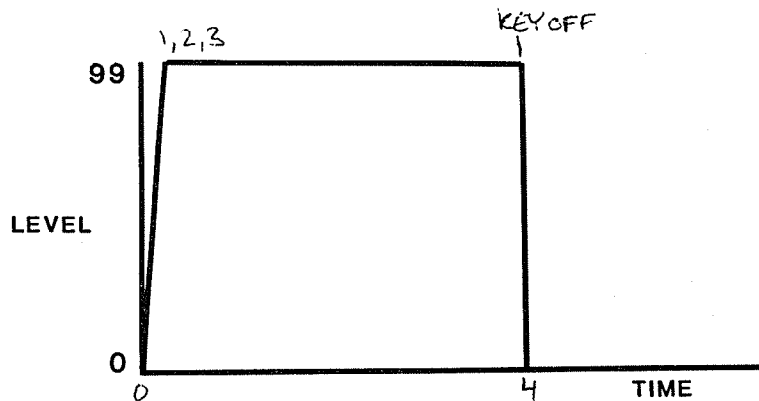

Loop	Repeat
OFF	

CHIFF (#33)

This program demonstrates subtle use of noise in the mixer envelope, producing a brief flute-like "chiff" at the sound's beginning.

Keyboard Mode

The keyboard is in Single mode, but the programmed Split and Double parameters can be activated by simply switching either keyboard mode switch on.

When **Double** is switched on, program #36 (SLOWBELL) is activated, with a 3-cent detune and no delay between the two programs. Switching **Split** on reconfigures the keyboard with program 36 playing to the left of the split point (D#3), and the main program (CHIFF) to the right. In either Split or Double mode, combining different programs with CHIFF is a simple matter of pressing **Link**, then adjusting the underlined LINK PROGRAM value with the slider.

Oscillator Group

Stepping through the four oscillator settings with **Oscillator Select**, we find that --with the exception of oscillator A, which is set to white noise-- all oscillators produce sine waves (wave #32) tuned to concert pitch (oscillator D), up one octave (oscillator B), and up an octave and a fifth (C). These pitches do not battle for dominance in this program however, because they are controlled by the mixer envelope.

Starting with essentially pure white noise at point 0, the mixer envelope quickly moves to the opposite end of the A-C axis, producing the woodwind "chiff" effect for which the program is named. Such effects on analog synthesizers are typically achieved by heavy filtering, which would also affect the tone of the sustaining waveforms. The VS's dynamic mixing allows complex timbral changes without modulating the filter at all.

Point 1 emphasizes the perfect fifth produced by oscillator C, and is also the only point at which oscillator B appears. Since rate 1 determines how fast point 1 is reached, you can change the duration of the chiff by simply adjusting rate 1. Points 2 and 3 are essentially the same point. Once the mixer envelope reaches point 2, the mix changes no further until the key is released. With **ALTERNATE RELEASE** footswitch held, the fifth becomes more apparent. (The oscillator C component of point 4 is not heard when the amplifier envelope release rate is 0.)

Since oscillator C is tuned up a fifth and an octave, the fifth does not dominate the sound as it would were it an octave lower. Try it out --select oscillator C and lower its coarse frequency to 7.

Filter

As mentioned above, the filter envelope is not responsible for this sound's changes in timbre. Selecting any control in the **Filter** group, we find that the initial envelope amount is zero. Looking at the modulation grid in the program form, you

will find that velocity modulates the filter envelope amount. The filter envelope produces a spike which, with increased velocity opens up the filter long enough to emphasize the initial noise burst produced by the mixer envelope.

The filter cutoff is set just high enough to make the white noise audible with low key velocity. Selecting **Cutoff** and adjusting to various values demonstrates how the programmed value of 62 is suitable for this application.

The keyboard modulation source is set for a medium-positive effect on the filter cutoff. This only affects the tone of oscillator A since the remaining oscillators all produce sine waves (hence, no harmonics) at frequencies well below the filter cutoff.

LFO Group

As the program form shows, each LFO modulation source modulates a pair of oscillators. Both LFOs produce triangle waveforms suitable for vibrato, but are at slightly different rates. As notes are held, only oscillators C and D are heard, so the modulation of oscillator B is not heard. (Oscillator A is noise, so modulation would have no effect in any case.) Both the pressure and mod wheel modulation sources control the depth of LFO modulation.

Voice Control

All voices are panned center, and no modulation occurs to cause motion in the stereo field.

Program Volume is set at 50 and the velocity modulation source amount is set to 84, allowing key velocity to drive the volume to its maximum. The amplifier envelope is a simple organ-style "on-off" envelope, with a long alternate release.

VOICE CONTROLS

PROPHET VS PROGRAM # 66

PERKEY

Unison/ Detune	Glide	Program Volume
OFF	0	56

KEYBOARD MODE

Split	Split Key	Link #	Double	Detune	Delay
OFF	C#3	52	OFF	0	0

LFO GROUP

	Shape	Rate
LFO 1	^	3
LFO 2	^	13

CHORUS

Left	Right	Rate	Depth
ON	ON	25	25

VOICE PAN

Voice 1	Voice 2	Voice 3	Voice 4	Voice 5	Voice 6	Voice 7	Voice 8
-1	-1	-1	-4	-5	-3	-1	-2

ARPEGGIATOR

Rate	Mode	Scan	Octaves	Repeats	Split	Voicing	Velocity	Layer	Rests
90	EXT	RAND	2	1	OFF	POLY	ON	OFF	ON

MODULATION

Source	Amount	Freq	Filter	Mix	LFO 1	LFO 2	Amp	Pan	Chorus
LFO 1	0	D		B-D		RATE + AMT			
LFO 2	24							ON	
Pressure	+23				AMT	AMT			
Velocity	+99		ENV				ENV		
Keyboard	+25		ON					ON	
Filter Env	0								
Mod Wheel					AMT				DEPTH

OSCILLATOR GROUP

Oscillator	Wave#	Freq
A	90	00.00
B	91	17.00
C	58	00.00
D	90	00.00

MIX ENVELOPE

Point	Rate	Level
0	/	0/51/49/0
1	0	0/0/50/50
2	13	91/0/0/9
3	7	64/0/0/36
4	0	62/38/0/0
4A	58	/

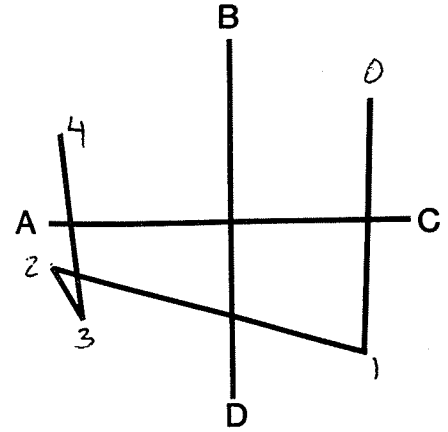

Loop	Repeat
OFF	

FILTER ENVELOPE

Point	Rate	Level
0	/	99
1	8	43
2	12	26
3	27	1
4	2	38
4A	67	/

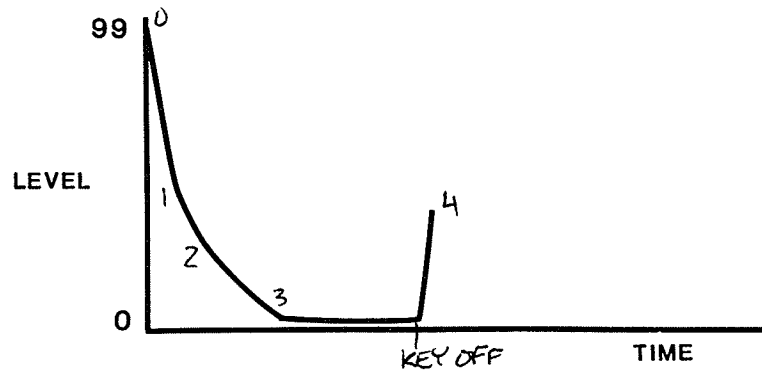

Loop	Repeat
OFF	

FILTER GROUP

Cutoff	Resonance	Env Amount
93	0	99

AMP ENVELOPE

Point	Rate	Level
0	/	99
1	0	48
2	20	28
3	59	0
4	26	0
4A	82	/

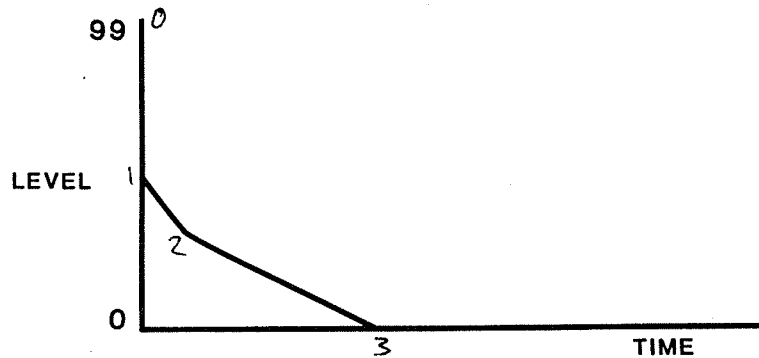

Loop	Repeat
OFF	

PERKEY (#66)

This percussive program ends with a metallic "clink" when keys are released. Monitoring in stereo reveals subtle voice panning. Tailoring the sustaining timbre of the sound may be accomplished by changing only one or two parameters in the oscillator group or mixer envelope.

Keyboard Mode

Normally, this program is in Single keyboard mode, but its Split and Double mode parameters can be activated by simply selecting either mode. Pressing **Split**, we find that the original program plays between C#3 and top C of the keyboard, while the linked program (#52 "GASEOSA") covers all keys below C#3. Pressing **Double**, the same two programs play simultaneously across the entire keyboard with no detuning between them.

Oscillator Group

The mixer envelope starts at a root/fourth blend of two complex bell-like waveforms (#91 and #58), instantly shifting to an equal mix of oscillators C and D (both at concert pitch), creating the program's percussive attack. If rate 1 is increased, the initial click becomes a chime.

As the envelope moves from point one to point two, oscillator A dominates the mix, the seventh harmonic --which dominates waveform #58 (oscillator C)--quickly fades out. The muting of oscillators C and D can be sped up or slowed down by varying rate 2. Combining different values for rates 1 and 2 can change the nature of the program dramatically.

The envelope quickly reaches its sustain point (#3), increasing the amount of oscillator D in the Mix. Changing rate 3 has little effect because points 2 and 3 are so close. However, if point 2 is moved, you may want to increase rate 3 for a smoother shift to the sustain mix.

By changing the waveform used by oscillators A or D, the program's sustaining timbre changes drastically, without affecting its percussive timbre. (Remember that oscillator C dominates the 50/50 mix of point 2.)

On release, the instant shift to a mix of oscillators A and B (tuned to concert pitch and up a fourth respectively) creates a final "plink" --but only if the note has not been sustained long enough for the amp envelope to decay to zero. With the **ALTERNATE RELEASE** footswitch depressed, all envelope release rates (#4) are extended, doing away with the program's abrupt ending.

Stepping through the modulation sources and destinations (with **Source Select** and **Dest Select**) shows that the A-C axis is slightly modulated by the keyboard, so that oscillator A is emphasized at the low end of the keyboard, and oscillator C is emphasized at the lower end. Meanwhile the B-D axis is modulated by LFO 1 when key pressure or the mod wheel is applied.

Filter

Although the filter envelope is set up for a short percussive spike with a sharp, positive-going release, it has no effect. Filter **Cutoff** is maximum, so the envelope has no effect even though **Env Amount** is also maximum. Similarly, the minor amount of keyboard modulation applied to the filter cutoff has negligible effect. However, as **Cutoff** is lowered, the effects of the filter envelope and velocity control become more pronounced. In the modulation section, the filter envelope source is not routed to any destinations.

LFO Group

All voices are initially panned near center, but LFO 2 slowly pans them towards either side by a programmed amount. LFO 1, running even slower than LFO 2, influences LFO 2's rate and depth of modulation, eventually determining how far voices are panned away from the center position.

Running much slower than LFO 2, LFO 1 also modulates oscillator D and the B-D mixer axis. Since its initial modulation amount is zero, its effect can only be heard by using the Mod wheel. As LFO 1 enters its positive phase, oscillator D is emphasized (and oscillator B de-emphasized) as its pitch rises, causing beating to increase between oscillator D and oscillators A and C.

Although turning the Mod wheel full up reveals that LFO 1 also modulates LFO 2's rate and depth, raising the Mod wheel beyond one third of its travel pushes the oscillator D modulation to its tolerable limits.

Pressure, on the other hand, increases both modulation amounts, and with its maximum influence limited (modulation amount is +23), does not run the same risks as the Mod wheel.

Voice Control

The amplifier envelope begins with a spike, then decays to zero in two stages in about three seconds. If keys are released before this decay is complete, a final clinking sound is heard, produced by the mixer envelope.

Stepping through the modulation section with **Source Select** and **DestSelect**, we find that velocity adds to the amplifier envelope amount. Since **Program Volume** is set at a medium level, velocity controls the volume between 56 and 99.

Arpeggiator

The arpeggiator operates in "Extend" mode. That is, any keys played (not necessarily held) are added to the arpeggiation. If **Split** is switched on, then all notes on the keyboard are arpeggiated similarly, regardless of their position relative to the split point. If desired, select the arpeggiator **SPLIT** option, and set to "DUAL". Notes to either side of the split point are then arpeggiated separately.

VOICE CONTROLS

Unison/ Detune	Glide	Program Volume
OFF	0	25

PROPHET VS PROGRAM # 40

IS THERE

KEYBOARD MODE

Split	Split Key	Link #	Double	Detune	Delay
OFF	C#3	16	OFF	0	0

LFO GROUP

	Shape	Rate
LFO 1	^	67
LFO 2	^	10

CHORUS

Left	Right	Rate	Depth
ON	ON	27	68

VOICE PAN

Voice 1	Voice 2	Voice 3	Voice 4	Voice 5	Voice 6	Voice 7	Voice 8
-46	-30	-21	-7	+9	+22	+32	+52

ARPEGGIATOR

Rate	Mode	Scan	Octaves	Repeats	Split	Voicing	Velocity	Layer	Rests
83	AUTO L	ASSIGN	1	1	OFF	POLY	OFF	OFF	OFF

MODULATION

Source	Amount	Freq	Filter	Mix	LFO 1	LFO 2	Amp	Pan	Chorus
LFO 1	0	A, B, C, D		B-D					
LFO 2	31			B-D					
Pressure	+53				AMT				
Velocity	+42			A-C					
Keyboard	0								
Filter Env	0								
Mod Wheel					AMT	AMT			

OSCILLATOR GROUP

Oscillator	Wave#	Freq
A	32	24.00
B	34	12.00
C	35	00.02
D	94	00.04

MIX ENVELOPE

Point	Rate	Level
0	/	0/1/99/0
1	8	0/0/0/100
2	15	27/21/23/24
3	30	0/100/0/0
4	49	100/0/0/0
4A	83	/

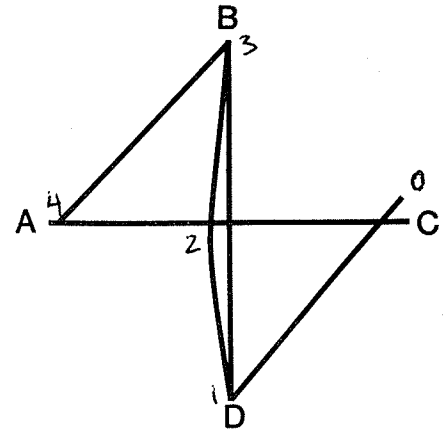

Loop	Repeat
OFF	

FILTER ENVELOPE

Point	Rate	Level
0	/	99
1	10	66
2	26	33
3	33	45
4	74	0
4A	64	

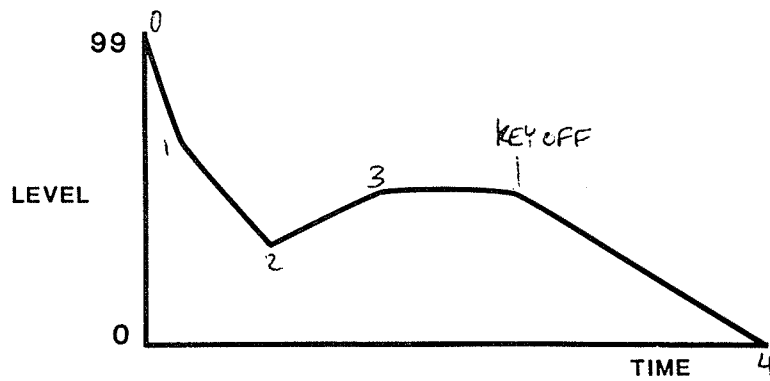

Loop	Repeat
OFF	

FILTER GROUP

Cutoff	Resonance	Env Amount
42	0	50

AMP ENVELOPE

Point	Rate	Level
0	/	99
1	11	73
2	17	58
3	26	50
4	67	0
4A	82	/

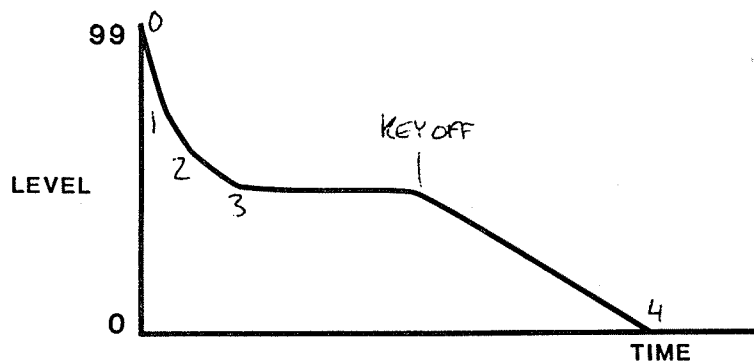

Loop	Repeat
OFF	

IS THERE (#40)

This program combines the punch of mallet percussion with the sustaining tone of a reed instrument, ending with a smooth tone at an octave above concert pitch. Velocity modulation of the mixer envelope provides dynamic timbral control going far beyond the capabilities of analog filters.

Keyboard Mode

Normally, this program is in Single keyboard mode, its Split and Double mode parameters can be activated by simply selecting either mode. Pressing **Split**, we find that the original program plays between C#3 and top C of the keyboard, while the linked program (#16, RONZONI) covers all keys below C#3. Pressing **Double**, the same two programs play simultaneously across the entire keyboard with no detuning between them.

Oscillator Group

Oscillators A, B, and C use relatively simple waveforms (32, 34, and 35 respectively) compared to the complex waveform used by oscillator D, which contains a healthy amount of the seventh harmonic. To create the "mallet" effect, the mixer envelope moves between oscillators C and B via points 1 and 2, emphasizing oscillator D only briefly, simulating the delayed resonant harmonics of, say, a steel drum. Rate 1 is responsible for the sound's reaction time.

The mixer envelope moves to its sustain point (point 3) in two stages at two rates. To exaggerate this motion, try setting mixer envelope rate 2 to "0" and "50", then compare.

The mixer envelope eventually sustains with only oscillator B in the mix (assuming the Mod wheel is not used). If desired, you could easily change the sustain tone by simply changing oscillator B's wave number. When a key is released, the mixer envelope moves from oscillator B towards oscillator A, which --as a sine wave at two octaves above concert pitch-- is an octave above oscillator B, and produces a third, smooth tone as the sound fades out.

Stepping through the modulation section with **Dest Select** and **Source Select**, velocity is shown to modulate the A-C axis. High velocities emphasize oscillator C throughout the envelope, while lower velocities emphasize oscillator A. Also, both LFOs modulate the B-D axis. LFO 1 has no initial modulation amount, so it is only effective when the Mod wheel is used. Since LFO 1 also modulates the pitch of all four oscillators, the Mod wheel can only be raised halfway before the tremolo effect drowns out the B-D axis modulation.

LFO 2's initial modulation amount is enough for subtle B-D axis movement, resulting in a slow variation in the amount of oscillator B heard as the sound sustains.

Filter

The filter cutoff is just low enough that it depends on the percussive filter envelope to accentuate the harmonics produced by oscillators B, C, and D. The filter envelope features a quick decay, followed by a rebound before completing its decay to zero. The envelope amount of 50 is suitable for the program, but may be adjusted as desired. No modulation sources are applied to the filter cutoff, and resonance is not used.

LFO Group

Both LFOs produce triangle waveforms for modulation, but only LFO 1 is used for vibrato. LFO 2 runs much slower and when the Mod wheel is used the combined effect of both LFOs can be heard. If desired, to get rid of the pitch modulation, select LFO 1 with **Source Select**, then select and switch off each of the four frequency destinations.

The Mod wheel adds to the initial modulation amounts of both LFOs, while pressure only adds to the amount of LFO 1.

Voice Control

Program Volume is set at 25, and a percussive envelope with a medium sustain level is used --suitable for the bright, percussive nature of the sound.

Voices are panned throughout the stereo image, but none appear entirely in either output. Although no modulation is applied to the pan destination, try switching on the LFO 2 to Pan routing for slow voice panning.

Chorus

Due to the limited modulation which occurs during the sustain period of this program, slow chorusing of both channels helps add subtle motion to the sound.

VOICE CONTROLS

Unison/ Detune	Glide	Program Volume
OFF	0	50

PROPHET VS PROGRAM # 44

SATIR

KEYBOARD MODE

Split	Split Key	Link #	Double	Detune	Delay
OFF	C3	46	OFF	0	0

LFO GROUP

	Shape	Rate
LFO 1	^	8
LFO 2	^	71

CHORUS

Left	Right	Rate	Depth
OFF	OFF	44	83

VOICE PAN

Voice 1	Voice 2	Voice 3	Voice 4	Voice 5	Voice 6	Voice 7	Voice 8
-5	0	+12	+4	-3	-10	-5	+5

ARPEGGIATOR

Rate	Mode	Scan	Octaves	Repeats	Split	Voicing	Velocity	Layer	Rests
70	EXT	U/D	1	1	OFF	POLY	ON	ON	OFF

MODULATION

Source	Amount	Freq	Filter	Mix	LFO 1	LFO 2	Amp	Pan	Chorus
LFO 1	0			A-C B-D		RATE			
LFO 2	0	A, C		B-D					
Pressure	-37	A, B, C, D							
Velocity	+42		ON	A-C B-D			ON	ON	
Keyboard	-99							ON	
Filter Env	-1								
Mod Wheel						AMT			DEPTH

OSCILLATOR GROUP

Oscillator	Wave#	Freq
A	71	12.00
B	71	12.15
C	92	00.18
D	92	00.07

MIX ENVELOPE

Point	Rate	Level
0	/	0/93/7/0
1	13	11/55/29/5
2	21	25/27/25/33
3	50	59/39/1/1
4	51	0/0/55/45
4A	88	/

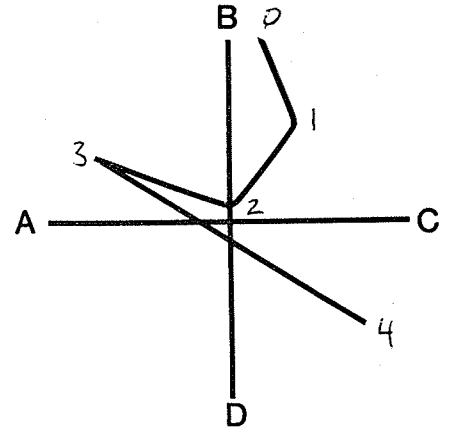

Loop	Repeat
OFF	

FILTER ENVELOPE

Point	Rate	Level
0	/	33
1	28	68
2	94	9
3	72	21
4	40	46
4A	57	/

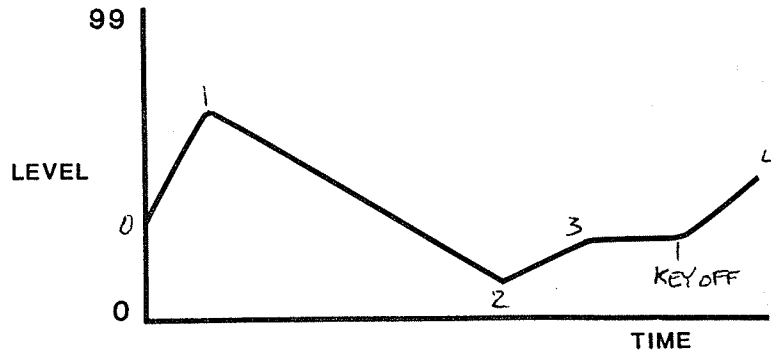

Loop	Repeat
OFF	

FILTER GROUP

Cutoff	Resonance	Env Amount
71	0	0

AMP ENVELOPE

Point	Rate	Level
0	/	0
1	4	99
2	29	63
3	73	58
4	63	0
4A	85	/

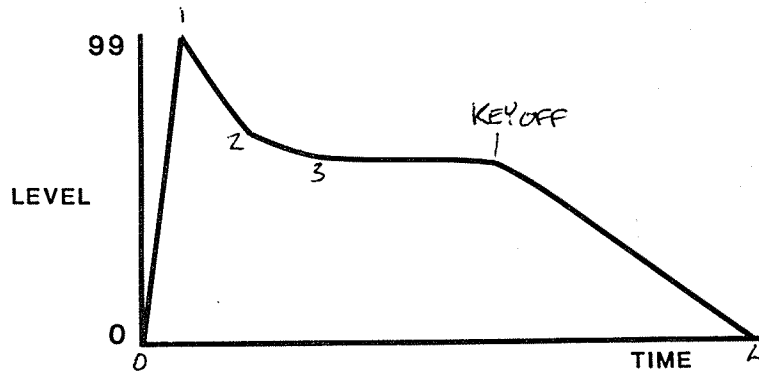

Loop	Repeat
OFF	

SATIR (#44)

Depending on how you play it, this program can take on vocal or sitar-like characteristics. Using the Mod wheel adds to the sound's shimmering tone.

Keyboard Mode

Normally, this program is in Single keyboard mode, its Split and Double mode parameters can be activated by simply selecting either mode. Pressing **Split**, we find that the original program plays between C3 and top C of the keyboard, while the linked program (#46, CLAVIBEL) covers all keys below C3. Pressing **Double**, the same two programs play simultaneously across the entire keyboard with no detuning between them.

Oscillator Group

Oscillators A and B both use waveform #71, which, when detuned as in this program, produces a voice-like resonant sound. Oscillators C and D both use waveform #92, a complex waveform suitable for metallic sounds. Like oscillators A and B, oscillators C and D are slightly detuned, assisting in simulating the sitar-like release of the program.

The mixer envelope is fairly simple: as a note is sustained, the oscillator mix shifts from oscillator B to a blend of oscillators A and B, passing briefly through the center of the oscillator diamond. As the mix point moves towards points 1 and 2, oscillators C and D add to the harmonic complexity of the sound, and as the mix point moves from point 2 to the sustain point (#3), many of the higher harmonics fade out, leaving the vocal timbre produced by detuned oscillators A and B.

When the note is released, the mix point begins to emphasize oscillators C and D again, until the other two oscillators are no longer present in the mix at all. When notes are played staccato, the program does not linger around the relatively static sustain point, and the release stage of the mixer envelope simulates the delayed resonance of a sitar's sympathetic strings.

If the Mod wheel is used, LFO 2 begins to detune oscillators A and C even farther, while at the same time, it causes shifts from oscillator B towards oscillator D and back, adding more motion to the sound.

Stepping through the modulation section with **Source Select** shows the pressure source has a negative modulation amount applied to the frequencies of all four oscillators. Thus, bearing down on the keyboard allows you to lower the program pitch slightly.

Looking through the modulation section shows that velocity has moderate influence over the filter envelope amount, the A-C and B-D axes, voice panning, and the overall volume.

Filter

The filter cutoff is just low enough to prevent the sound from being too piercing when played with low key velocity. In the modulation section, velocity is routed to the filter, so that as key velocity increases, so does the envelope amount. Since **Cutoff** and the velocity source amount are both reasonably high, the filter cutoff is controllable over a narrow range and --beyond medium key velocities-- the only timbral changes which occur are due to the velocity modulation of the A-C and B-D mixer axes.

LFO Group

LFO 1 is not used. Its modulation amount is zero, and the Mod wheel does not add to this.

As explained before, LFO 2 is responsible for increasing the shimmering sound of the program by detuning two of the oscillators against the other two. It uses a triangle waveform at a rate suitable for tremolo, but could be slowed down and still be useful in this application. LFO 2's initial amount is zero, so the depth of its effect depends entirely on use of the Mod wheel.

Voice Control

All voices are panned near stereo center, and are not moved much farther by the programmed amount of velocity modulation, but the negative amount of keyboard modulation does cause notes played at the top of the keyboard to appear in the left audio output, and low notes to appear in the right audio output. If desired, this effect could be reversed by selecting the keyboard modulation source, and changing the amount to +99. (Higher notes then appear in the right audio outputs.)

The amplifier envelope features a fast-attack, ADSR-shaped envelope for a medium high sustain volume. **Program Volume** is 50 and the velocity modulation source amount is +42, allowing key velocity to drive the volume near its maximum.

VOICE CONTROLS

Unison/ Detune	Glide	Program Volume
OFF	0	54

PROPHET VS PROGRAM # 69

FILMUSIC

KEYBOARD MODE

Split	Split Key	Link #	Double	Detune	Delay
OFF	C1	69	ON	16	208

LFO GROUP

	Shape	Rate
LFO 1	^	64
LFO 2	^	71

CHORUS

Left	Right	Rate	Depth
ON	ON	20	75

VOICE PAN

Voice 1	Voice 2	Voice 3	Voice 4	Voice 5	Voice 6	Voice 7	Voice 8
0	0	0	0	0	0	0	0

ARPEGGIATOR

Rate	Mode	Scan	Octaves	Repeats	Split	Voicing	Velocity	Layer	Rests
60	NORM	UP	1	1	OFF	POLY	ON	OFF	OFF

MODULATION

Source	Amount	Freq	Filter	Mix	LFO 1	LFO 2	Amp	Pan	Chorus
LFO 1	13	D							
LFO 2	14	B							
Pressure	-34	A							
Velocity	+73		ENV				ENV		
Keyboard	+32		ON						
Filter Env	0								
Mod Wheel						AMT			

OSCILLATOR GROUP

Oscillator	Wave#	Freq
A	67	00.00
B	75	05.00
C	76	07.00
D	74	12.00

MIX ENVELOPE

Point	Rate	Level
0	/	100/0/0/0
1	45	27/73/0/0
2	45	0/0/72/28
3	47	31/69/0/0
4	57	34/66/0/0
4A	55	/

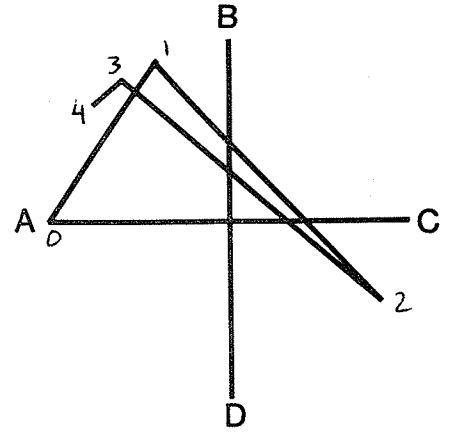

Loop	Repeat
0 ↔ 3	C

FILTER ENVELOPE

Point	Rate	Level
0	/	0
1	45	56
2	44	42
3	46	34
4	59	30
4A	64	/

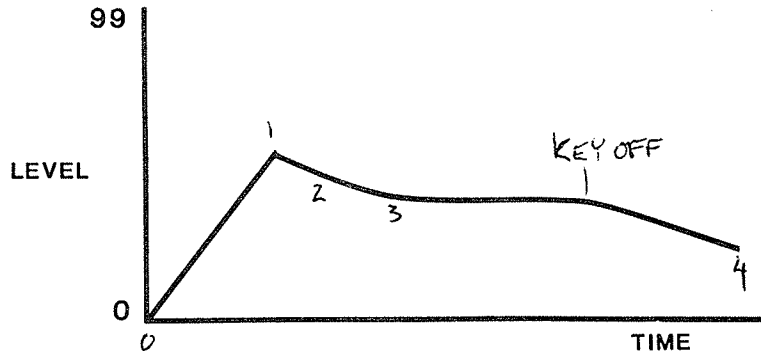

Loop	Repeat
OFF	

FILTER GROUP

Cutoff	Resonance	Env Amount
43	0	26

AMP ENVELOPE

Point	Rate	Level
0	/	0
1	26	86
2	25	68
3	36	58
4	67	0
4A	82	

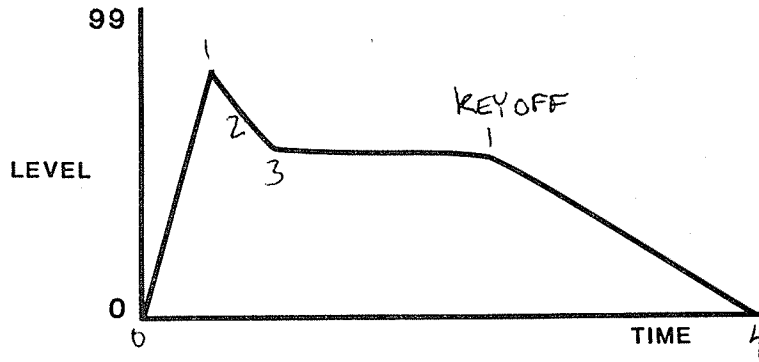

Loop	Repeat
OFF	

FILMUSIC (#69)

This program produces vocal sounds which fade slowly between four pitches, two of which are LFO-modulated for tremolos which fade in and out. Although not necessarily an ideal program for lead lines, it can produce interesting, rich textures with only a few voices.

Keyboard Mode

This program is in Double keyboard mode, and is linked to itself with a 208-msec delay and minor detuning. This causes an overlapping of different pitches as the program loops. To hear the program without this layering, switch **Double** off.

Oscillator Group

Waveforms 67, 74, 75, 76 are used for vocal resonant qualities, tuned at desired intervals with no fine tuning. If desired, try selecting and adjusting **Coarse Frequency** for each oscillator.

The mix envelope moves steadily through points 0 through 4, with each point determining the order in which the four pitches are heard. The mixer envelope is set to loop back and forth between points 0 and 3, causing the pattern to repeat. As the program is in double mode, these pitches lag each other by 208 msec (1/5 second), creating interesting harmonies.

Looking through the modulation section shows that LFO 1 modulates oscillator D, and LFO 2 modulates oscillator B. Since the mixer envelope fades between these two oscillators between points 1 and 3, the effects of the LFOs appears to fade in and out slowly. Since oscillators B and D are at different pitches, and the LFOs run at different rates, the program takes on an ensemble texture.

The pressure modulation source has a negative amount, and when used, lowers the pitch of oscillator A, its only modulation destination.

For other interesting effects, make a copy of this program which loops between points 1 and 3 (rather than between points 0 and 3), then double that program with this one, so that the resulting harmonies repeat less often.

Filter

The filter cutoff is low enough to allow discernable variations in the amount of filter envelope modulation. Velocity and keyboard modulation sources contribute to the increased "swept filter" effect. The filter envelope has an ADSR shape, with a slow attack. Unlike the mixer envelope, the filter envelope does not loop.

LFO Group

Both LFOs run at similar rates --both suitable for tremolo-- and although they also have similar modulation source amounts, the Mod wheel is programmed to add to the depth of LFO 2 only.

Voice Control

All voices are panned center, and no modulation is applied to drive the voices towards either audio output.

The amplifier envelope, like the filter envelope, has an ADSR shape with a slow attack so the delayed attack of the linked program does not interrupt the progression of the mixer envelope. Program Volume is high enough to allow only a limited amount of velocity control over the sound's volume.

Chorus

The slow rate and medium depth of the chorus is essential to maintain motion in the slowly fading oscillators.

Arpeggiator

Due to the nature of this program, the arpeggiator's CLOCKS/STEP control must be set as high as possible --for the slowest possible rate-- or each arpeggiated note will not be sustained long enough to evolve.

VS WAVEFORM DESCRIPTIONS

To audition any waveform on its own:

1. Switch **Edit Waveform** on.
2. Move the joystick for 100% mix of any of the four oscillators.
3. Select the corresponding oscillator with **Oscillator Select**.
4. Press **Wave#**.
5. Adjust the slider for the desired wave number.
6. Play the keyboard to hear the selected waveform.
7. To include specific waveforms in a program, switch **Edit Waveform** off, then edit the Oscillator Group controls as explained in the Prophet VS operation manual.

The following are some of the waveforms included in the VS's internal ROM.

<u>Wave#</u>	<u>Name</u>	<u>Comments</u>
32	Sine	This is the purest waveform available and is the bulding block of all waveforms. Whether or not you have the patience or inclination to create complex waveforms with it is another matter.
33	Sawtooth	Typically used for brass patches, this waveform is featured on most analog synthesizers. It is equally valid on the VS and combines well with other complex waveforms.
34	Square	Another standard analog waveform. Works well for traditional "string synth" sounds.
45 and 46	Pulse waveforms	Both have the "nasal" qualities of narrow pulse waveforms. Subtle differences.
56		The fundamental is absent in this one. The third and fifth harmonics dominate.
58		Heavy seventh harmonic.
60	BASSBELL	14th and 28th harmonics.
75 & 76	Vocal	On their own, these waveforms may not appear to be derived from a voice sample, but detuning two oscillators using either waveform brings out the vocal qualities.

<u>Wave#</u>	<u>Name</u>	<u>Comments</u>
113 and 125	Bell partials	These waveforms are suitable for bell-like sounds.
115	Sawtooth 3rd and 5th	3rd and 5th harmonics overpower the fundamental.
116	Sine Fifths	Two sine waves an octave and a fifth apart.
117	Sine 2-Octave	Two sine waves two octaves apart.
118	Sine 4-Octave	Two sine waves four octaves apart.
119	Sawtooth Fifths	Two sawtooth waveforms an octave and a fifth apart.
120	Sawtooth 2-Octaves	Two sawtooth waveforms two octaves apart.
121	Square Fifths	Two square waveforms a fifth apart.
122	Square Octave+fifth	Two square waves an octave and a fifth apart.
123	Square 2-Octaves	Two square waveforms two octaves apart.
126	Null	Used to switch an oscillator "off" (without reprogramming the mixer envelope away from that oscillator).
127	Noise	White noise.

SECTION 16

PROGRAM FORMS

OSCILLATOR GROUP

Oscillator	Wave#	Freq
A		
B		
C		
D		

MIX ENVELOPE

Point	Rate	Level
0		
1		
2		
3		
4		
4A		

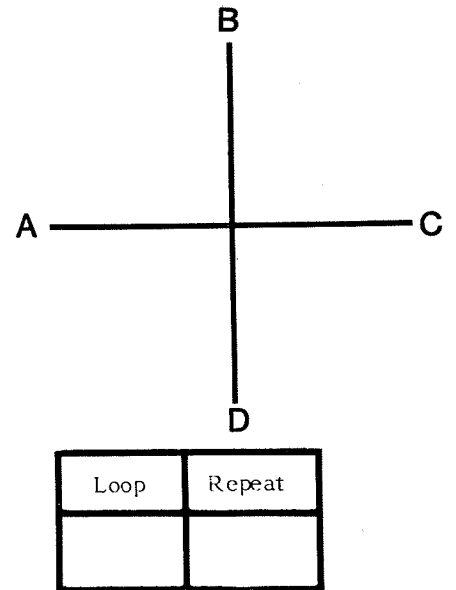

FILTER ENVELOPE

Point	Rate	Level
0		
1		
2		
3		
4		
4A		

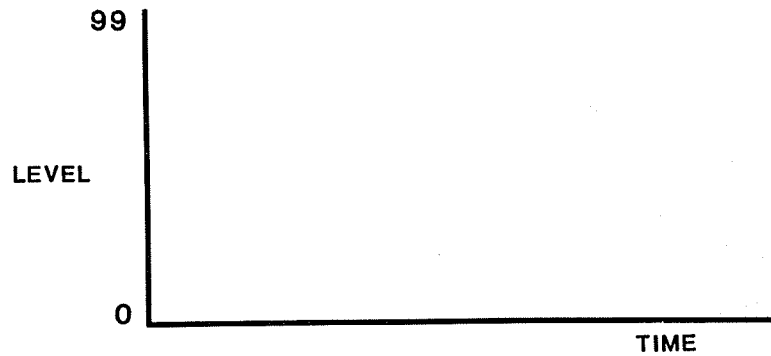

Loop	Repeat

FILTER GROUP

Cutoff	Resonance	Env Amount

AMP ENVELOPE

Point	Rate	Level
0		
1		
2		
3		
4		
4A		

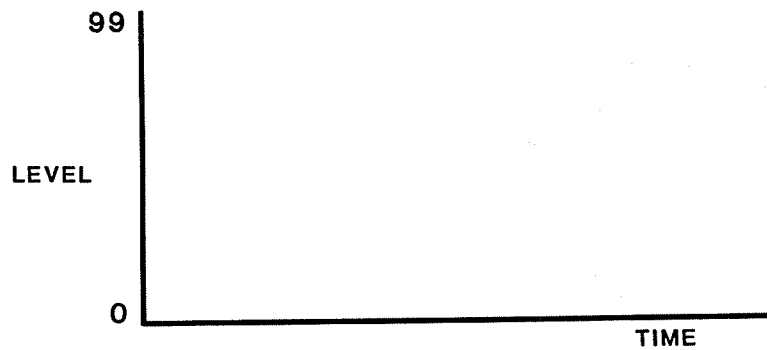

Loop	Repeat

OSCILLATOR GROUP

Oscillator	Wave#	Freq
A		
B		
C		
D		

MIX ENVELOPE

Point	Rate	Level
0		
1		
2		
3		
4		
4A		

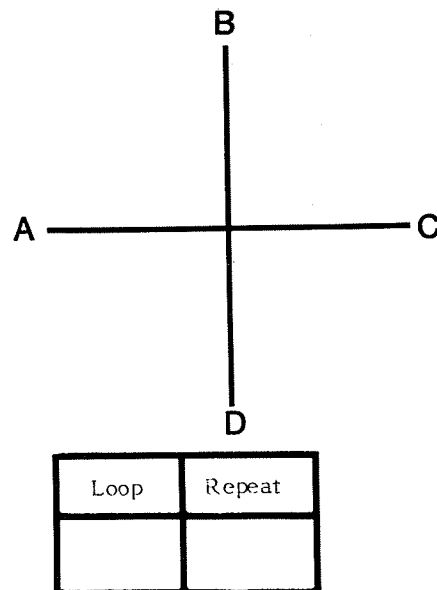

FILTER ENVELOPE

Point	Rate	Level
0		
1		
2		
3		
4		
4A		

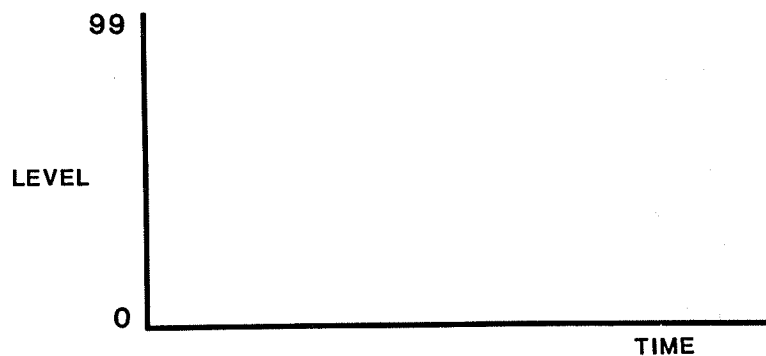

Loop	Repeat

FILTER GROUP

Cutoff	Resonance	Env Amount

AMP ENVELOPE

Point	Rate	Level
0		
1		
2		
3		
4		
4A		

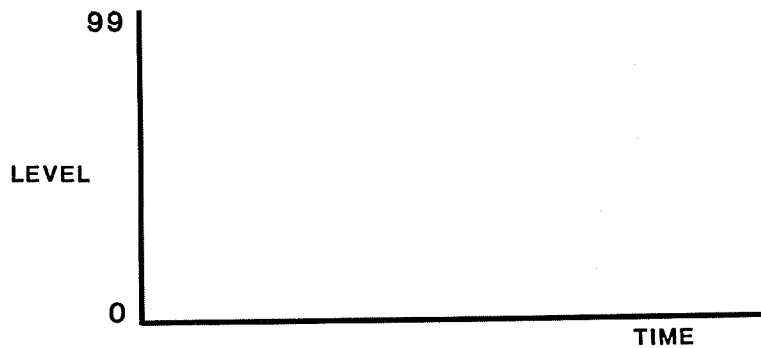

Loop	Repeat

OSCILLATOR GROUP

Oscillator	Wave#	Freq
A		
B		
C		
D		

MIX ENVELOPE

Point	Rate	Level
0		
1		
2		
3		
4		
4A		

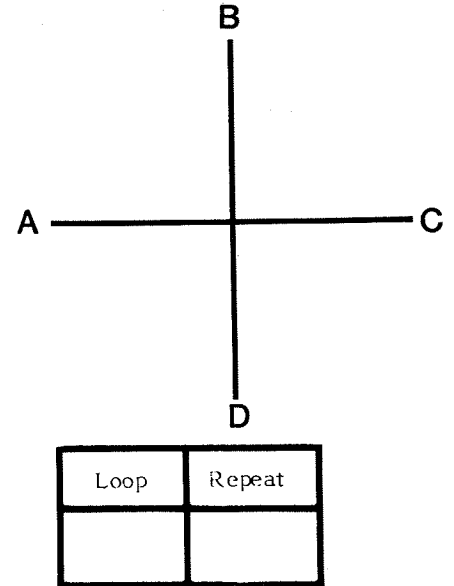

FILTER ENVELOPE

Point	Rate	Level
0		
1		
2		
3		
4		
4A		

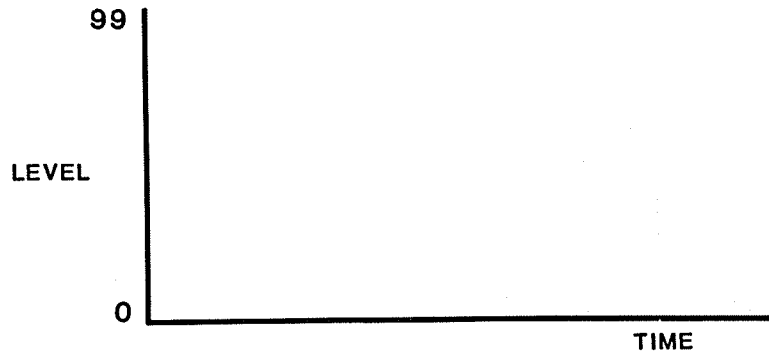

Loop	Repeat

FILTER GROUP

Cutoff	Resonance	Env Amount

AMP ENVELOPE

Point	Rate	Level
0		
1		
2		
3		
4		
4A		

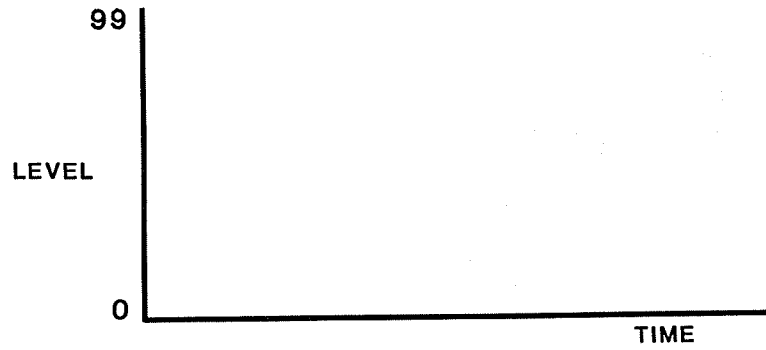

Loop	Repeat

OSCILLATOR GROUP

Oscillator	Wave#	Freq
A		
B		
C		
D		

MIX ENVELOPE

Point	Rate	Level
0		
1		
2		
3		
4		
4A		

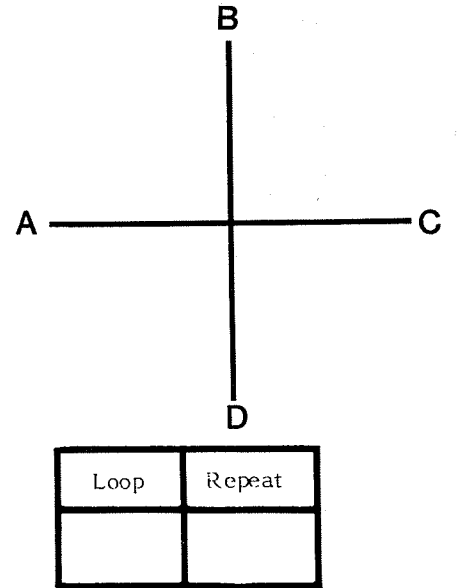

FILTER ENVELOPE

Point	Rate	Level
0		
1		
2		
3		
4		
4A		

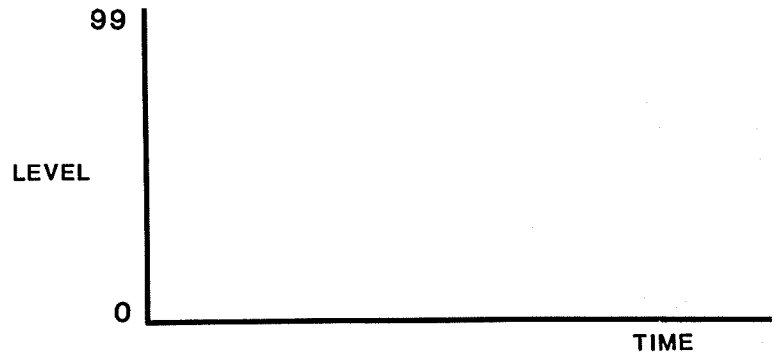

Loop	Repeat

FILTER GROUP

Cutoff	Resonance	Env Amount

AMP ENVELOPE

Point	Rate	Level
0		
1		
2		
3		
4		
4A		

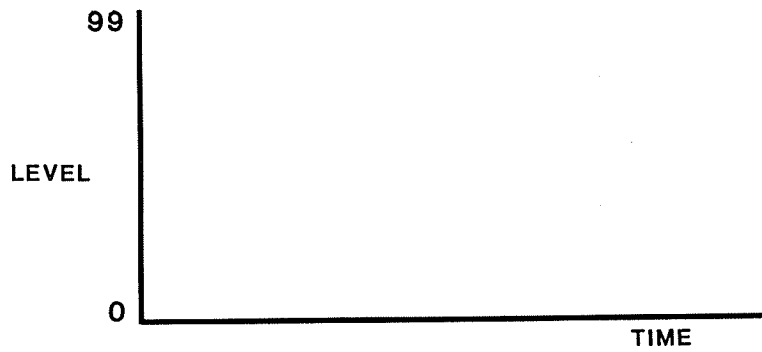

Loop	Repeat

OSCILLATOR GROUP

Oscillator	Wave#	Freq
A		
B		
C		
D		

MIX ENVELOPE

Point	Rate	Level
0		
1		
2		
3		
4		
4A		

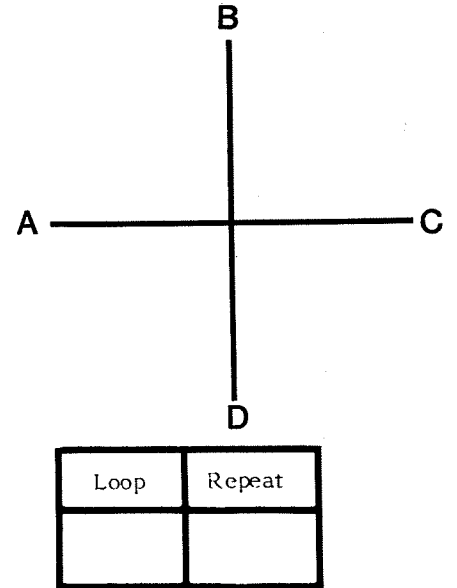

FILTER ENVELOPE

Point	Rate	Level
0		
1		
2		
3		
4		
4A		

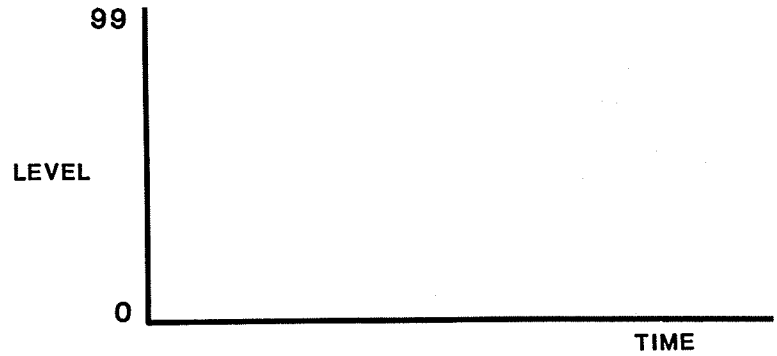

Loop	Repeat

FILTER GROUP

Cutoff	Resonance	Env Amount

AMP ENVELOPE

Point	Rate	Level
0		
1		
2		
3		
4		
4A		

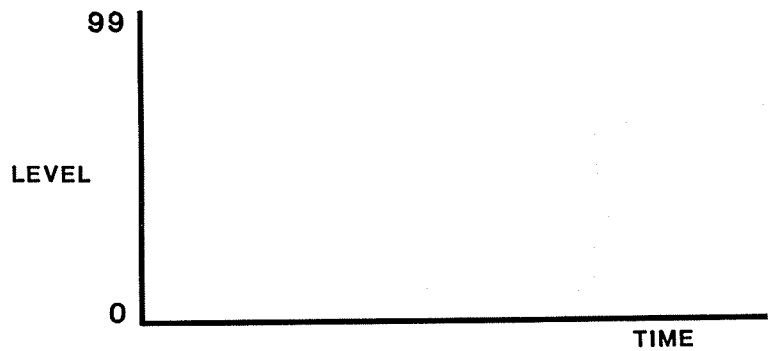

Loop	Repeat

OSCILLATOR GROUP

Oscillator	Wave#	Freq
A		
B		
C		
D		

MIX ENVELOPE

Point	Rate	Level
0		
1		
2		
3		
4		
4A		

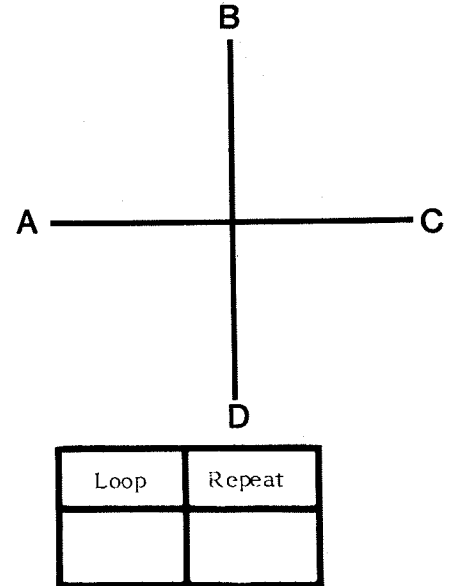

FILTER ENVELOPE

Point	Rate	Level
0		
1		
2		
3		
4		
4A		

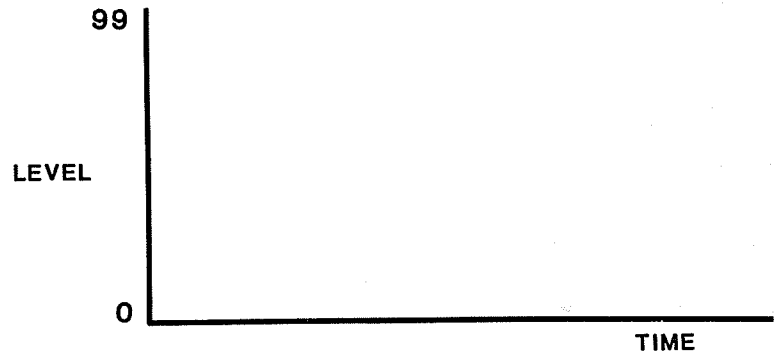

Loop	Repeat

FILTER GROUP

Cutoff	Resonance	Env Amount

AMP ENVELOPE

Point	Rate	Level
0		
1		
2		
3		
4		
4A		

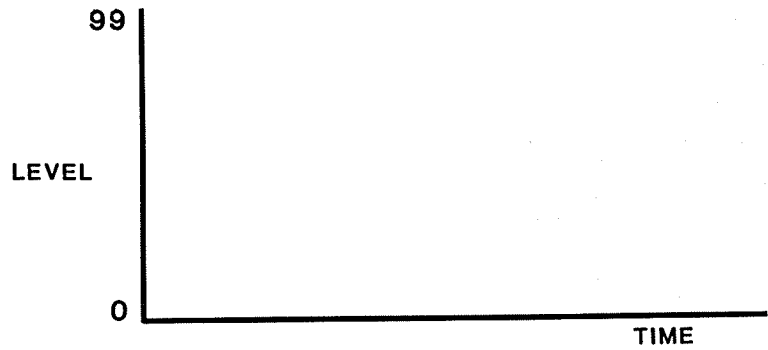

Loop	Repeat

OSCILLATOR GROUP

Oscillator	Wave#	Freq
A		
B		
C		
D		

MIX ENVELOPE

Point	Rate	Level
0		
1		
2		
3		
4		
4A		

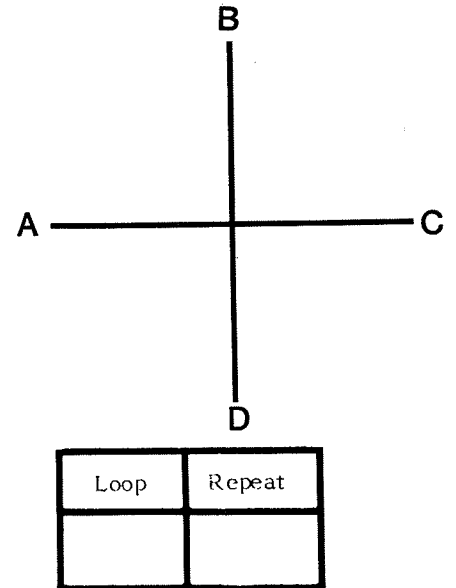

FILTER ENVELOPE

Point	Rate	Level
0		
1		
2		
3		
4		
4A		

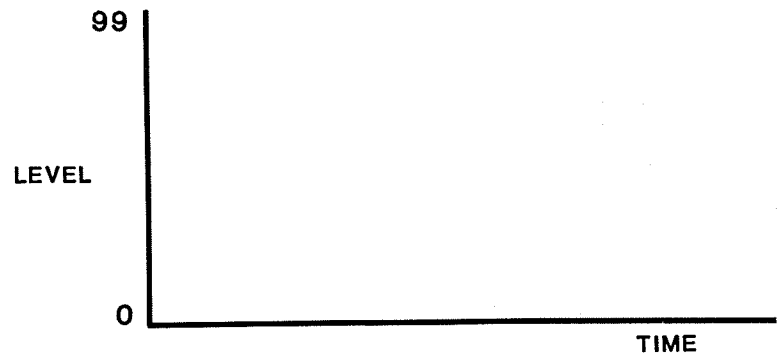

Loop	Repeat

FILTER GROUP

Cutoff	Resonance	Env Amount

AMP ENVELOPE

Point	Rate	Level
0		
1		
2		
3		
4		
4A		

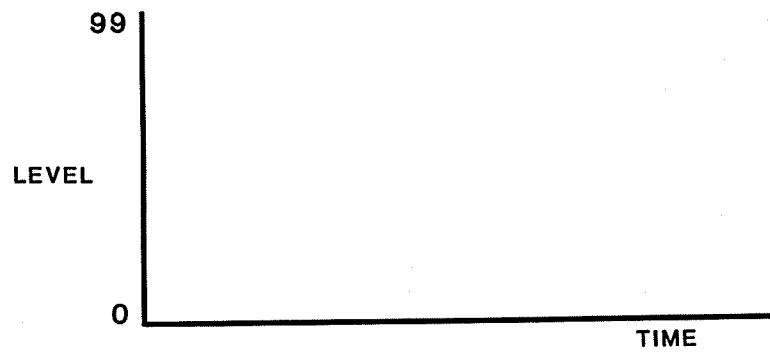

Loop	Repeat

OSCILLATOR GROUP

Oscillator	Wave#	Freq
A		
B		
C		
D		

MIX ENVELOPE

Point	Rate	Level
0		
1		
2		
3		
4		
4A		

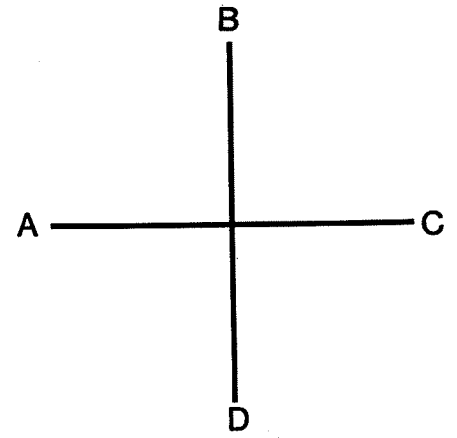

Loop	Repeat

FILTER ENVELOPE

Point	Rate	Level
0		
1		
2		
3		
4		
4A		

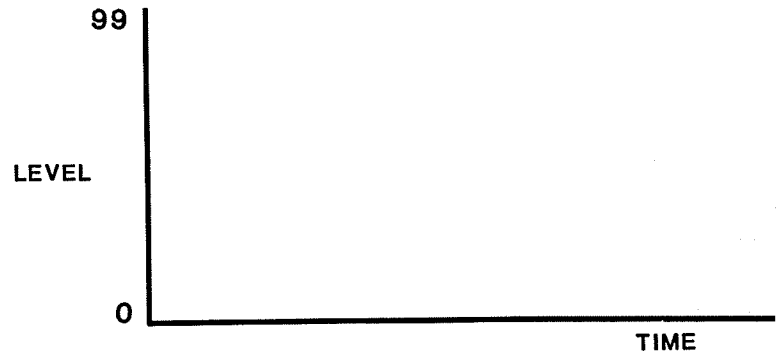

Loop	Repeat

FILTER GROUP

Cutoff	Resonance	Env Amount

AMP ENVELOPE

Point	Rate	Level
0		
1		
2		
3		
4		
4A		

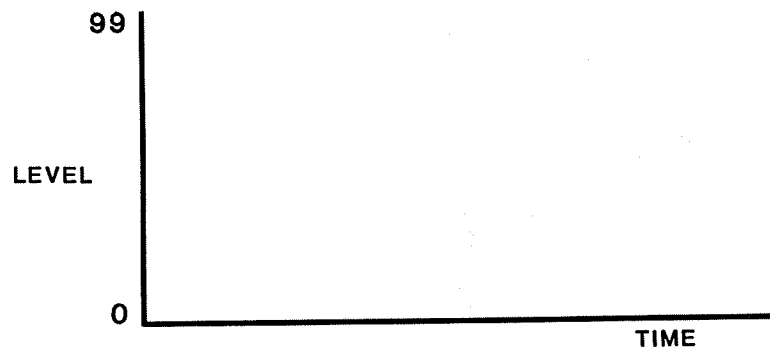

Loop	Repeat

OSCILLATOR GROUP

Oscillator	Wave#	Freq
A		
B		
C		
D		

MIX ENVELOPE

Point	Rate	Level
0		
1		
2		
3		
4		
4A		

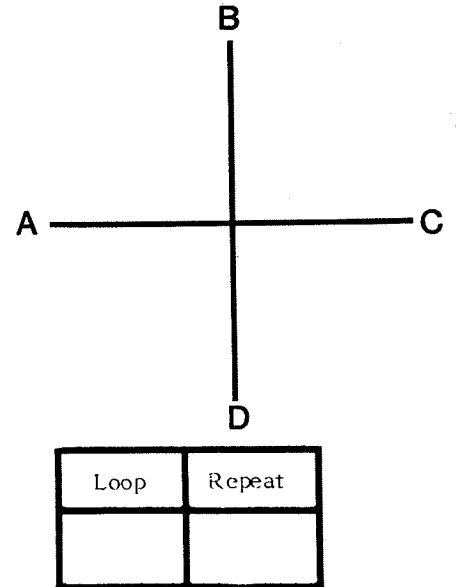

FILTER ENVELOPE

Point	Rate	Level
0		
1		
2		
3		
4		
4A		

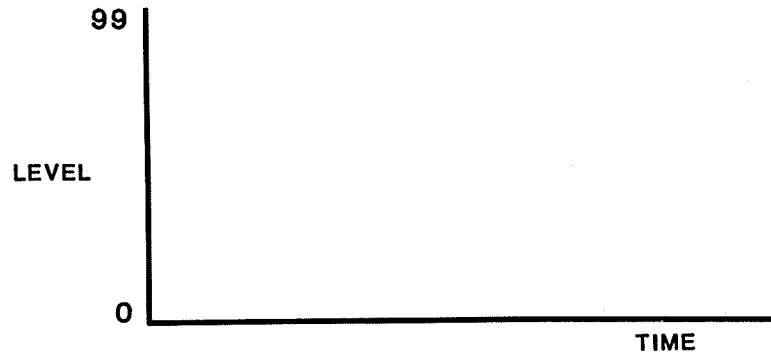

Loop	Repeat

FILTER GROUP

Cutoff	Resonance	Env Amount

AMP ENVELOPE

Point	Rate	Level
0		
1		
2		
3		
4		
4A		

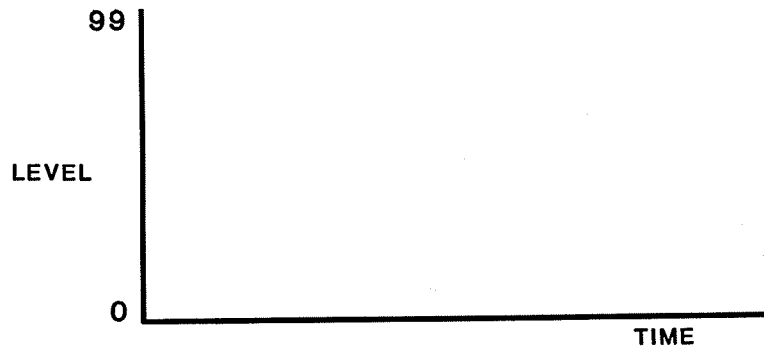

Loop	Repeat